

**TABLE OF CONTENTS**

<b>1. INTRODUCTION</b> .....	<b>3</b>	<b>4.4.15</b> Supervision .....	<b>12</b>
<b>2. SPECIFICATIONS</b> .....	<b>3</b>	<b>4.4.16</b> NOT READY .....	<b>12</b>
<b>2.1</b> General Data .....	<b>3</b>	<b>4.4.17</b> AUX Button .....	<b>12</b>
<b>2.2</b> RF Section .....	<b>3</b>	<b>4.4.18</b> Jam Detect .....	<b>12</b>
<b>2.3</b> Electrical Data .....	<b>3</b>	<b>4.4.19</b> Latchkey .....	<b>12</b>
<b>2.4</b> Communication .....	<b>4</b>	<b>4.4.20</b> "Not Active" .....	<b>13</b>
<b>2.5</b> Physical Properties .....	<b>4</b>	<b>4.4.21</b> Back Light .....	<b>13</b>
<b>3. INSTALLATION</b> .....	<b>4</b>	<b>4.4.22</b> Duress .....	<b>13</b>
<b>3.1</b> Unpacking the Equipment .....	<b>4</b>	<b>4.4.23</b> Piezo Siren .....	<b>13</b>
<b>3.2</b> Supplying Power to the Unit .....	<b>4</b>	<b>4.4.24</b> Reset Option .....	<b>13</b>
<b>3.3</b> System Planning and Programming .....	<b>4</b>	<b>4.4.25</b> Tamper Option .....	<b>13</b>
<b>3.4</b> Mounting .....	<b>4</b>	<b>4.4.26</b> Siren on Line .....	<b>13</b>
<b>3.5</b> Wiring .....	<b>4</b>	<b>4.4.27</b> Memory Prompt .....	<b>13</b>
<b>3.6</b> Connecting the AC Transformer .....	<b>7</b>	<b>4.4.28</b> Disarm Option .....	<b>13</b>
<b>3.7</b> Installing an Optional X-10 Siren .....	<b>7</b>	<b>4.4.29</b> Bell/Rep. Option .....	<b>13</b>
<b>3.8</b> Connecting PowerMax+ to a Computer .....	<b>7</b>	<b>4.4.30</b> Low-Bat ACK .....	<b>13</b>
<b>3.9</b> Connecting PowerMax+ to GSM Modem .....	<b>7</b>	<b>4.4.31</b> Screen Saver .....	<b>13</b>
<b>4. PROGRAMMING</b> .....	<b>7</b>	<b>4.4.32</b> Confirm Alarm .....	<b>13</b>
<b>4.1 INTRODUCTION</b> .....	<b>7</b>	<b>4.4.33</b> AC Fail Rep .....	<b>13</b>
<b>4.1.1</b> General Guidance .....	<b>7</b>	<b>4.4.35</b> User Permission .....	<b>13</b>
<b>4.1.2</b> Entering an Invalid Installer Code .....	<b>8</b>	<b>4.5 DEFINING COMMUNICATION PARAMETERS</b> .....	<b>15</b>
<b>4.1.3</b> Installer's Menu .....	<b>8</b>	<b>4.5.1</b> Autotest Time .....	<b>15</b>
<b>4.1.4</b> Setting a New Installer Code .....	<b>8</b>	<b>4.5.2</b> Autotest Cycle .....	<b>15</b>
<b>4.1.5</b> Setting a New Installer Code in PowerMax+ that has 2 Installer Codes .....	<b>8</b>	<b>4.5.3</b> Area Code .....	<b>15</b>
<b>4.2 ENROLLING WIRELESS DEVICES AND KEYFOBS</b> .....	<b>9</b>	<b>4.5.4</b> Out Access Code .....	<b>15</b>
<b>4.2.1</b> General Guidance .....	<b>9</b>	<b>4.5.5</b> First Central Station Telephone .....	<b>15</b>
<b>4.2.2</b> Enrolling Type .....	<b>10</b>	<b>4.5.6</b> First Account No. ....	<b>15</b>
<b>4.2.3</b> Enroll / Delete Wireless Devices .....	<b>10</b>	<b>4.5.7</b> Second Central Station Telephone .....	<b>15</b>
<b>4.2.4</b> Enroll / Delete Keyfob Transmitters .....	<b>10</b>	<b>4.5.8</b> Second Account No. ....	<b>15</b>
<b>4.2.5</b> Enroll / Delete Wireless Commander .....	<b>10</b>	<b>4.5.9</b> Report Format .....	<b>15</b>
<b>4.2.6</b> Enroll / Delete Wireless Siren .....	<b>10</b>	<b>4.5.10</b> 4/2 Pulse Rate .....	<b>15</b>
<b>4.3 DEFINING ZONE TYPES, NAMES &amp; CHIME ZONES</b> .....	<b>10</b>	<b>4.5.11</b> Reporting to Central Stations .....	<b>15</b>
<b>4.4 DEFINING CONTROL PANEL PARAMETERS</b> .....	<b>11</b>	<b>4.5.12</b> Report CNF Alarm .....	<b>15</b>
<b>4.4.1</b> Preliminary Guidance .....	<b>11</b>	<b>4.5.13</b> Send 2WV Code .....	<b>15</b>
<b>4.4.2</b> Entry Delays 1&2 .....	<b>11</b>	<b>4.5.14</b> Two-Way Voice Central Stations .....	<b>15</b>
<b>4.4.3</b> Exit Delay .....	<b>11</b>	<b>4.5.15</b> Ring Back Time .....	<b>17</b>
<b>4.4.4</b> Bell Time .....	<b>11</b>	<b>4.5.16</b> Dialing Attempts .....	<b>17</b>
<b>4.4.5</b> Abort Time .....	<b>11</b>	<b>4.5.17</b> Set Private Telephone No. ....	<b>17</b>
<b>4.4.6</b> Alarm Cancel .....	<b>11</b>	<b>4.5.18</b> Two-Way Voice - Private Phones .....	<b>17</b>
<b>4.4.7</b> Quick Arm .....	<b>12</b>	<b>4.5.19</b> Private Telephone Dialing Attempts .....	<b>17</b>
<b>4.4.8</b> Bypass .....	<b>12</b>	<b>4.5.20</b> Reporting to Private Telephones .....	<b>17</b>
<b>4.4.9</b> Exit Mode .....	<b>12</b>	<b>4.5.21</b> Telephone Acknowledge .....	<b>17</b>
<b>4.4.10</b> Piezo Beeps .....	<b>12</b>	<b>4.5.22</b> Pager Telephone Number .....	<b>17</b>
<b>4.4.11</b> Trouble Beeps .....	<b>12</b>	<b>4.5.23</b> Pager's PIN No. ....	<b>17</b>
<b>4.4.12</b> Panic Alarm .....	<b>12</b>	<b>4.5.24</b> Reporting to a Pager .....	<b>17</b>
<b>4.4.13</b> Swinger Stop .....	<b>12</b>	<b>4.5.25</b> Recent Closure .....	<b>17</b>
<b>4.4.14</b> Cross Zoning .....	<b>12</b>	<b>4.5.26</b> Remote Access .....	<b>17</b>
		<b>4.5.27</b> Master Downloader Code .....	<b>17</b>
		<b>4.5.28</b> Installer Downloader Code .....	<b>17</b>

4.5.29 Unit ID .....	17	5.3 Keyfob Transmitter Test .....	23
4.5.30 Zone Restore .....	17	5.4 Appliance ON/OFF Test .....	23
4.5.31 Upload Option .....	17	5.5 Emergency Transmitter Test .....	24
4.5.32 Dialing Method .....	17	<b>6. MAINTENANCE.....</b>	<b>24</b>
4.5.33 Line Failure Report .....	17	6.1 Dismounting the Control Panel.....	24
4.5.34 UL/DL Telephone Number.....	18	6.2 Replacing the Backup Battery .....	24
4.5.35 System Inactive Report.....	18	6.3 Fuse Replacement .....	24
<b>4.6 DEFINING GSM PARAMETERS.....</b>	<b>18</b>	6.4 Replacing/Relocating Detectors.....	24
4.6.1 GSM installed.....	18	<b>7. READING THE EVENT LOG .....</b>	<b>24</b>
4.6.2 1st, 2nd, 3rd & 4th SMS Numbers.....	18	<b>APPENDIX A. DETECTOR DEPLOYMENT AND</b>	
4.6.3 Reporting to SMS Phone Number .....	18	<b>TRANSMITTER ASSIGNMENTS .....</b>	<b>25</b>
4.6.4 GSM Line Failure Reporting .....	19	A.1 Detector Deployment Plan .....	25
4.6.5 GSM Line Purpose.....	18	A.2 Keyfob Transmitter List .....	25
<b>4.7 DEFINING OUTPUT PARAMETERS .....</b>	<b>19</b>	A.3 Emergency Transmitter List .....	26
4.7.1 Preliminary Guidance.....	19	A.4 Non-Alarm Transmitter List.....	26
4.7.2 Defining PGM .....	19	<b>APPENDIX B. X-10 UNIT AND PGM OUTPUT</b>	
4.7.3 Defining INT/STRB .....	19	<b>ASSIGNMENTS .....</b>	<b>26</b>
4.7.4 X-10 General Def.....	19	<b>APPENDIX C. EVENT CODES .....</b>	<b>27</b>
4.7.5 X-10 Unit Define.....	19	<b>APPENDIX D. PROGRAMMABLE ZONE TYPES.....</b>	<b>28</b>
<b>4.8 RECORDING SPEECH .....</b>	<b>21</b>	<b>APPENDIX E. POWERMAX+ COMPATIBLE DEVICES.....</b>	<b>29</b>
<b>4.9 DIAGNOSTIC TEST.....</b>	<b>21</b>	E1 PowerMax+ Compatible Detectors .....	29
<b>4.10 USER FUNCTIONS .....</b>	<b>22</b>	E2 PowerMax+ Compatible Transmitters.....	30
<b>4.11 RETRIEVING FACTORY DEFAULTS.....</b>	<b>22</b>	E3 PowerMax+ Compatible WL Siren.....	30
<b>4.12 SERIAL NUMBER .....</b>	<b>22</b>	E4 PowerMax+ Compatible GSM Modem.....	30
4.13 Calling Upload/Download Server .....	22	<b>FCC Statements .....</b>	<b>31</b>
<b>5. TESTING PROCEDURES .....</b>	<b>23</b>	<b>Declaration of Conformity.....</b>	<b>32</b>
5.1 Preparations.....	23		
5.2 Diagnostic Test.....	23		

## MESSAGE TO THE INSTALLER

The PowerMax+ control panel is supplied with 2 instruction manuals:

■ **Installation and Programming Guide** (this manual - for your exclusive use)

■ **User's Guide** (for your use during installation only - Must be handed over to the master user after testing the system).

Appendices A.1 and A.2 will help you prepare an installation plan. Please take time to fill out the forms - your job will become much easier and confusion will be prevented. Filling out the forms will also help you create a list of detectors and transmitters that must be obtained for the particular application. Compatible detectors and transmitters are listed and described briefly in Appendix E.

Remember - it is advisable to power up the control panel temporarily after unpacking and program it on the work bench, in accordance with the installation plan.

The programming flow charts in the programming section show all options available for each parameter. Factory defaults are marked with a dark box to their right, and other options (that can be selected instead) are marked by clear boxes. This method allows you to put a checkmark in the appropriate clear box whenever you deviate from the factory defaults.

Most of the programming section paragraph numbers correlate with the programming menu numbers. For example, paragraph 4.4.18 describes the "Jam detect", that exists in menu 4 (define panel), sub-menu 18 (Jam detect).

Although setting the correct time and date is one of the user tasks, we recommend that you set the time and date in the course of programming. Access to the "User Settings" for the installer is possible through item 10 on the installer's menu or through the user menu (see User's manual section 7).

After programming, proceed to install the system as detailed in the Installation Instructions, from paragraph 3.4 onward.

**WARNING! Zone type "emergency" can not be used for medical applications in UL-listed systems.**

The installer should verify line seizure. Be aware of other phone line services such as DSL.

# 1. INTRODUCTION

The PowerMax+ is a user and installer-friendly, 30-zone fully-supervised wireless control system. The system is designed to function in a way that appeals to the user but also offers features that make installers' life easier than ever before:

## EASY TO INSTALL

- Plug-in terminal blocks can be wired while detached from the unit.
- Quick attach-detach TELCO sockets for telephone line and X-10 controller. Terminal block for telephone line & set.
- Special wall-mounted bracket permits installation without having to open the unit's cabinet.
- Optional plug-in RS-232 module for local computer.

## EASY TO MAINTAIN

- Status, alarm memory and trouble data are displayed upon request.

- Diagnostic test provides visual and audible indication of the signal level of each detector.
- Remote control and status verification from distant telephones.
- Event log stores and displays information on 100 past events.
- Upload / download from distant computer via telephone line and modem.

## QUICK PROGRAMMING

- Multiple-choice selection of options for each parameter.
- Unequivocal visual prompts and audible signals.
- Installer access to the user menu.

A fully equipped alarm system based on the PowerMax+ consists of the units shown in Figure 2 of the user's guide.

# 2. SPECIFICATIONS

## 2.1 General Data

**Zones Number:** 28 wireless, 2 hardwired (zones 29 & 30).

**Hardwired Zone Requirements:** 2.2 k $\Omega$  E.O.L. resistance (max. resistance of wires 220  $\Omega$ ).

**Zone Types:** Interior follower, perimeter, perimeter follower, delay 1, delay 2, 24h silent, 24h audible, fire, non-alarm, emergency, gas and flood.

**User Codes:** 8 codes, 4 digits each

### Control Facilities:

- Integral keypad
- PowerCode / Code-Secure™ hand-held transmitters
- Wireless commander, MCM-140+
- Remote telephone
- Local or remote computer

**Display:** Single line, back lighted 16-character LCD and 4 LED indicators.

**Arming Modes:** AWAY, HOME, AWAY-INSTANT, HOME-INSTANT, LATCHKEY, FORCED, BYPASS.

**Alarm Types:** Silent alarm, siren alarm or sounder (internal) alarm, in accordance with zone attributes.

**Siren Signals:** Continuous (intrusion / 24 hours / panic); triple pulse - pause - triple pulse... (fire).

**Siren (bell) Timeout:** Programmable (4 min. by default)

**Internal Sounder Output:** At least 85 dBA at 10 ft (3 m)

**Supervision:** Programmable time frame for inactivity alert

### Special Functions:

- Speech and sound control
- Powerline Carrier Device Control (up to fifteen X-10 brand units) by various factors, as programmed
- Chime zones
- Diagnostic test and event log
- Remote control by telephone
- Computer control and data download/upload
- Calling for help by using an emergency transmitter
- Tracing inactivity of elderly, physically handicapped and infirm people
- Message center (recording and playback)
- Two-way voice communication

**Data Retrieval:** Status, alarm memory, trouble, event log.

**Real Time Clock:** The control panel keeps and displays time and date.

### Compliance with U.S. Standards:

Meets FCC Part 15 and Part 68 requirements.  
UL1023 - Household Burglar Alarm System Unit - Grade A.  
UL985 - Household fire warning System.  
UL1635 - Digital Alarm Communicator System Units.

### Compliance with European Standards:

**EMC Emission:** EN 50081-1 1992, EN300220-3

**RFI:** EN55022 1998

**EMC Immunity:** EN 50082-1 1997, EN301489-3

**EMC Immunity to Conducted RF:** EN6100-4-6 1996

**Telephony:** TBR21 1998

**Safety:** EN60950+ Am1(93), Am2(93), Am3(95), Am4(97)

According to the European standard EN5013-1, the PowerMax+ security grading is 2 - "low to medium risk" and environmental classification is II - "indoor general".

The PowerMax+ is compatible with the RTTE requirements - Directive 1999/5/EC of the European Parliament and of the Council of 9 March 1999.

## 2.2 RF Section

**Operating Frequencies:** 315 MHz (in USA & Canada) or other UHF channels per local requirement in the country of use.

**Receiver Type:** Super-heterodyne, fixed frequency

**Receiver Range:** 600 ft (180 m) in open space

**Antenna Type:** Spatial diversity

**Coding:** PowerCode and/or CodeSecure™

## 2.3 Electrical Data

**Power Supply:** Plug-in transformer.

120 VAC, 60 Hz / 9 VAC, 1A (in the U.S.A.)

230 VAC, 50 Hz / 9 VAC, 1A

**Note:** It is possible to use 700 mA transformer if the used siren current consumption is less than 300 mA.

**UL installation:** Use transformer type OH-41111AT, manufactured by Oriental Hero Electrical Factory.

**In Europe and elsewhere:** Use only Safety National Approved AC adapter, mains-to-9 VAC, 0.7A or 1A.

**Current Drain:** Approx. 65 mA standby, 800 mA at full load and in alarm.

**Site External Siren Current (EXT):** 450\* mA max @ 10.5 VDC when powered by AC & DC (battery).

**Site Internal Siren Current (INT):** 450\* mA max. @ 10.5 VDC when powered by AC & DC (battery)

**PGM Output Current:** 100\* mA max.

**Detector 1 & 2 Total (Sum) Current:** 100\* mA max.

**High Current / Short Circuit Protection:** All outputs are protected (current limited).

\* Total PowerMax+ output current (of INT & EXT sirens, PGM output and detectors) cannot exceed 600 mA. Total INT & EXT sirens current consumption cannot exceed 550 mA. **For UL installations, total output current cannot exceed 550 mA.**

**Backup Battery Pack** (provides power for at least 24 hours), according to the purchase option:

**Option 1** (applicable for **UL** installations): 7.2V 2100 mAh, rechargeable NiMH battery pack, p/n GP211ATH6XML, manufactured by GP, trickle charge 80 mA approx.

**Option 2:** 9.6V Nickel Cadmium or Nickel Metal rechargeable battery pack, 650 to 1800 mAh.

*Note: To use a non-Visonic battery pack, its battery snap should have proper polarity!*

**Battery Test:** Once every 10 seconds.

## 2.4 Communication

**Built-in Modem:** 300 baud, Bell 103 protocol

**Data Transfer to Local Computer:** Via RS232 serial port

**Report Destinations:** 2 central stations, 4 private telephones, 1 pager.

**Reporting Format Options:** SIA, Pulse 4/2 1900/1400 Hz, Pulse 4/2 1800/2300 Hz, Contact ID, Scancom.

**Pulse Rate:** 10, 20, 33 and 40 pps - programmable

**Message to Private Phones:** Tone or voice

**Message to Pager:** PIN No. → Alarm Type → Zone No.

## 2.5 Physical Properties

**Operating Temp. Range:** 32°F to 120°F (0°C to 49°C)

**Storage Temp. Range:** -4°F to 140°F (-20°C to 60°C)

**Humidity:** 85% relative humidity, @ 30°C (86°F)

**Size:** 10-13/16 x 8 x 2-1/8 in. (275 x 203 x 55 mm)

**Weight:** 990g (2.2 pounds) without batteries

**Color:** Ivory and charcoal gray

# 3 INSTALLATION

## 3.1 Unpacking the Equipment

Open the cardboard packing box and check whether all items have been included. If you find out that an item is missing, contact your vendor or dealer immediately.

## 3.2 Supplying Power to the Unit

Enrolling the transmitting devices' ID codes in the PowerMax+ memory will be easier if carried out before actual installation, with all detectors and the control panel on a work bench. It is therefore necessary to power up the PowerMax+ temporarily from the external power transformer (see figure 3.3). Alternatively, you may power up from the backup battery, as shown in figure 3.1.

**Disregard any "trouble" indications that may appear** (due to lack of battery or lack of telephone line connection).

## 3.3 System Planning & Programming

It pays off to plan ahead - use the tables in appendices A and B at the end of this guide to register the intended location of each detector, the holder and assignment of each transmitter and the control plan for the X-10 units.

Gather up all transmitters and detectors used in the system and mark each one in accordance with your deployment plan.

**Program the system now as instructed in the programming section.**

## 3.4 Mounting

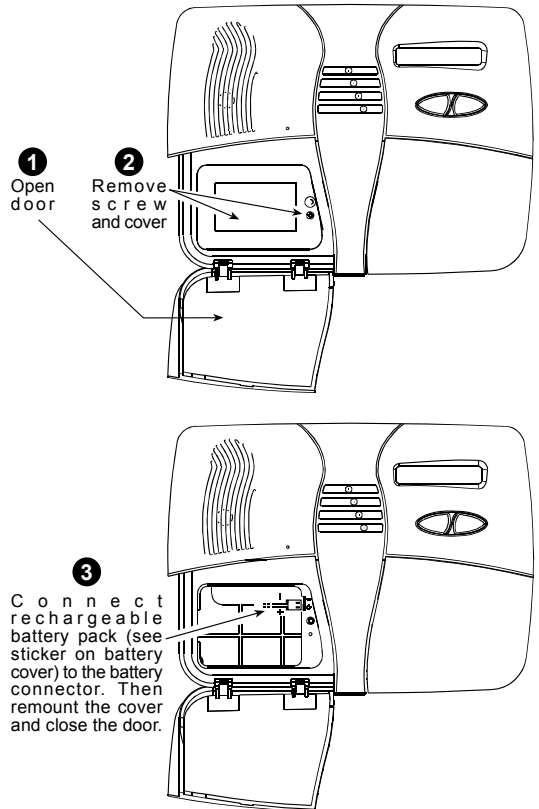
PowerMax+ mounting process is shown in figure 3.2.

## 3.5 Wiring

PowerMax+ wiring is shown in figure 3.3.

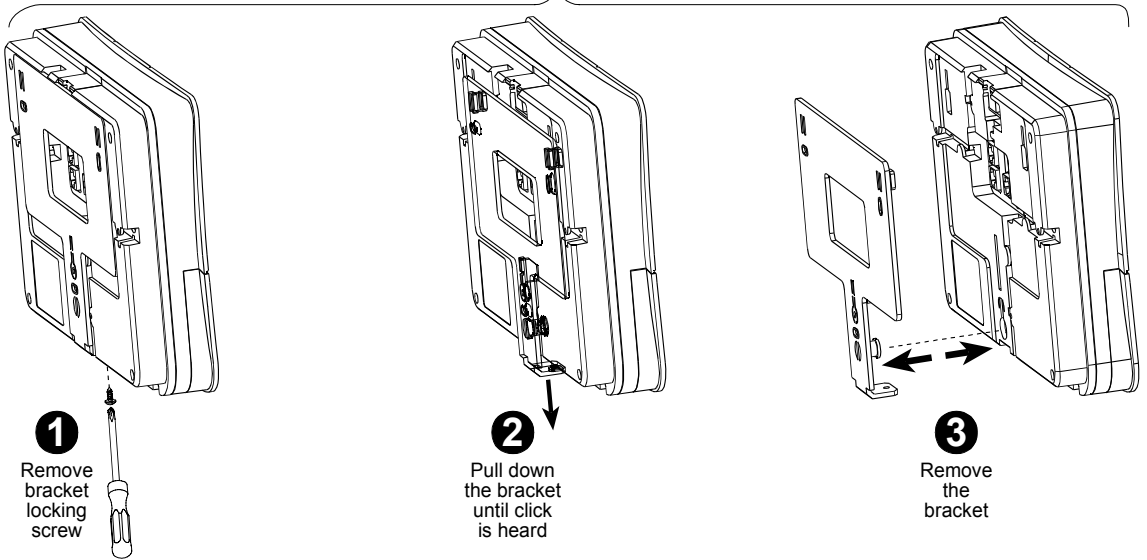
Extract the screw terminal blocks one by one and make the necessary connections. When done, plug each terminal block onto its PCB mounted pins.

You will need 6-lead RJ-11 cord(s) for telephone line or telephone line and telephone set.

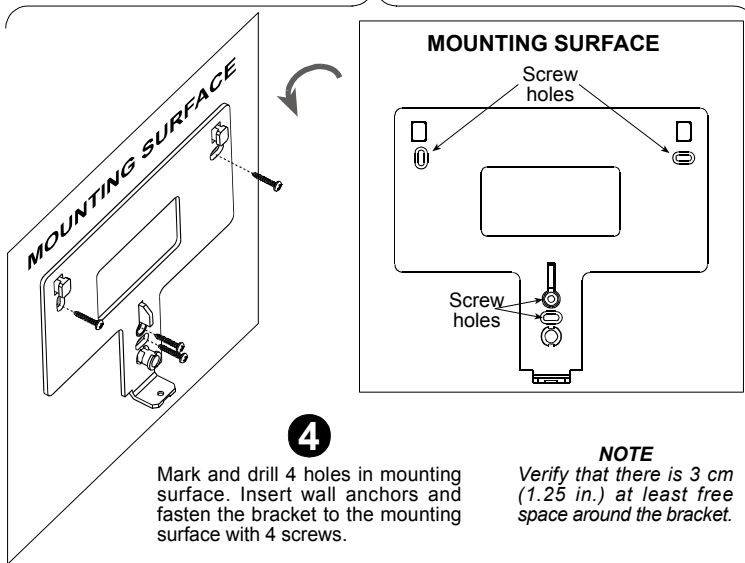


**Figure 3.1 - Backup Battery Insertion**

## BRACKET REMOVAL



## BRACKET MOUNTING



## MOUNTING ON THE RACKET

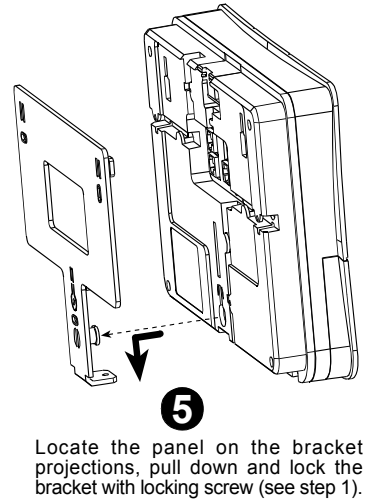
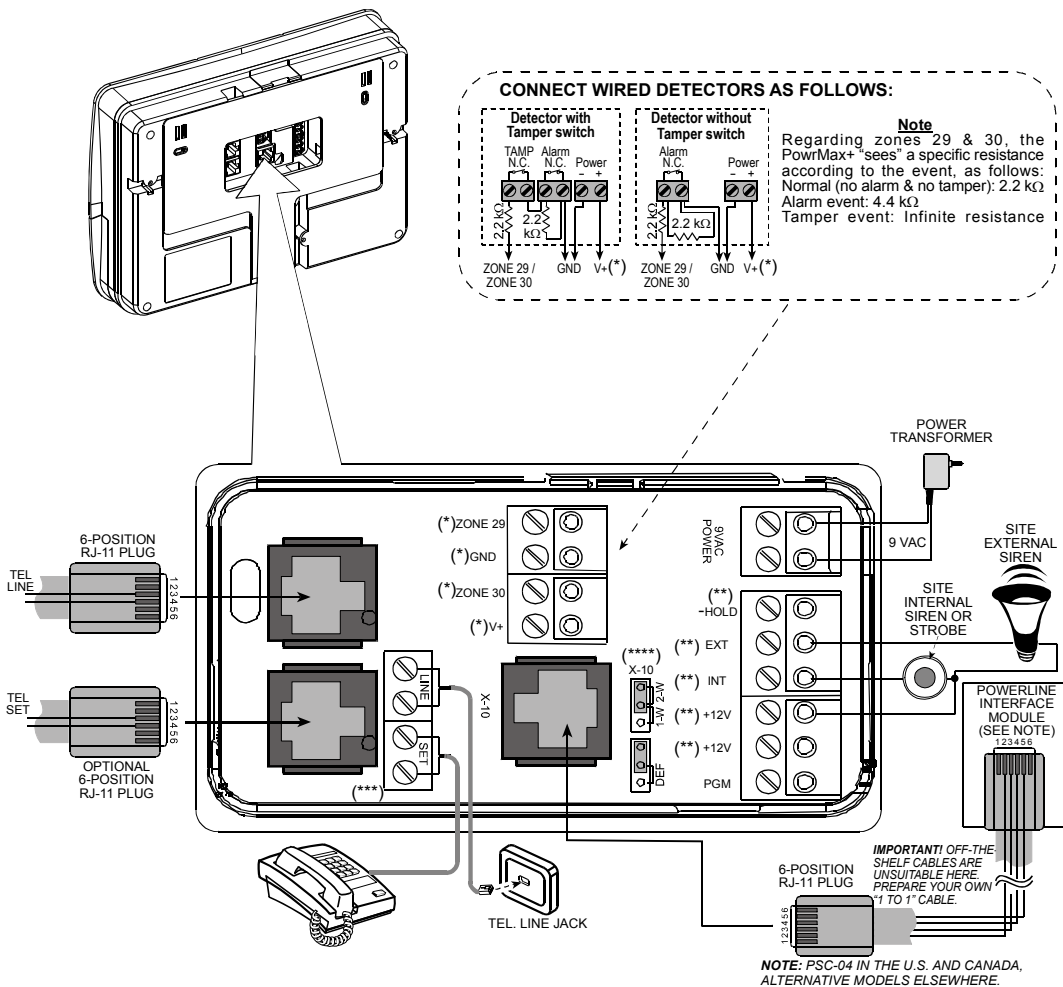


Figure 3.2 – Mounting



**Figure 3.3 - Wiring Diagram**

**Notes:**

- \* Zone 29/GND and Zone 30/GND terminals can be connected to a normally closed contact of a detector, switch (for example a Tamper switch of any device), or a pushbutton, via a 2.2 kΩ resistor. Such a resistor is connected at the factory across both Zone 29/GND and Zone 30/GND terminals. The resistors should remain there if the terminals are not used. **The V+ terminal can be used to supply 12V (up to 100mA) to a detector (if necessary).**
- \*\* Both +12V terminals are identical (shorted together). The +12V and "-Hold" terminals can be connected to a siren (for constant DC power supply) and the INT or EXT terminal can be used to trigger such a siren. The INT terminal can be programmed to "internal siren" or "strobe" (see DEFINE OUTPUTS - DEFINE AUX in par. 4.7).
- \*\*\* Removable LINE SET terminals or connector (RJ-11), according to the purchase option.
- \*\*\*\* The X-10 jumper should be in 1-W position (for 1-way power line interface unit) or in 2-W position (for 2-way power line interface unit).

**WARNING!** When plugging terminals back into place, be sure to align them carefully with the pins on the PCB. Misaligned or reverse insertion of terminals may damage internal PowerMax+ circuits!

**IMPORTANT!** The terminals for internal and external sirens are DC outputs intended for 12V sirens. Connecting a loudspeaker to any of these outputs will cause a short circuit and will damage the unit.

**Notes for UL installations**

- a. The site INTERNAL SIREN and EXTERNAL SIREN are suitable for burglar alarm application only. They are not suitable for fire alarm signaling. If external siren is used, it must be UL listed and shall be rated to operate under the voltage specified in the Specifications.
- b. A device that is connected to PGM terminal should not be programmed to be activated during standby.
- c. The system shall be installed in accordance with Chapter 2 of the National Fire Alarm Code, ANSI/NFPA 70.
- d. All wiring should be acceptable for class 1 systems as defined by the National Electrical Code, ANSI/NFPA 70. No. 26 AWG or larger telecommunication line cord shall be used.
- e. The system shall be installed in accordance with CSA C22.1 Canadian Electrical Code, Part 1.
- f. A minimum spacing of 1/4 inch shall be maintained between the telephone wiring and the low voltage wiring (zones, bell circuit, etc). Do not route the LINE and SET wires in the same wiring channel with other wires.

- g. The current of the Site External Siren (EXT) or Internal Siren (INT) shall not exceed 550 mA.

### 3.6 Connecting the AC Transformer

**CAUTION!** Do not plug the transformer into the AC outlet before completing all other wiring.

- A. **U.S.A. only:** Remove the center screw from the AC wall outlet.
- B. Plug the transformer directly in - the Power LED of the control panel should illuminate.
- C. **U.S.A. only:** Use the screw removed in Step A above to secure the transformer to the AC outlet. Tighten the screw well.
- D. The distance of the transformer from the system should not exceed 150 ft using 18 AWG conductors.

**For UL installations, do not connect to a receptacle controlled by a switch.**

### 3.7 Installing an Optional X-10 Siren

(Not to be used in UL-listed systems)

If you need a "wireless" external siren, you may install an X-10 siren module which is triggered by a signal transmitted via the built-in electrical wiring of the protected site. This siren can replace the regular external siren or complement it without laying out additional wires. Of course, such a siren can be used only in conjunction with an optional power-line interface module.

The X-10 siren is ready to function upon connection to an electrical power outlet, without re-programming the PowerMax+. You only have to set the HOUSE CODE and the UNIT CODE selectors on the X-10 siren as follows:

**House Code:** Set this selector to the letter that follows, by alphabetical order, the letter that you programmed as a house code for the protected premises. For example, if the programmed house code is "J", set the siren house code selector to "K".

**Note:** If the programmed house code letter is "P" (which is the last programmable letter), select "A" for the siren.

**Unit Code:** The siren will function only if you set the unit code selector to "1".

### 3.8 Connecting PowerMax+ to Computer

The control panel can be equipped with an optional RS232 module for serial data interchange with a local computer. If this module is not supplied, a special plastic cap blocks the niche designed to accommodate the module.

**Attention:** For data download from a local computer, the PowerMax+ must be set to the installer mode.

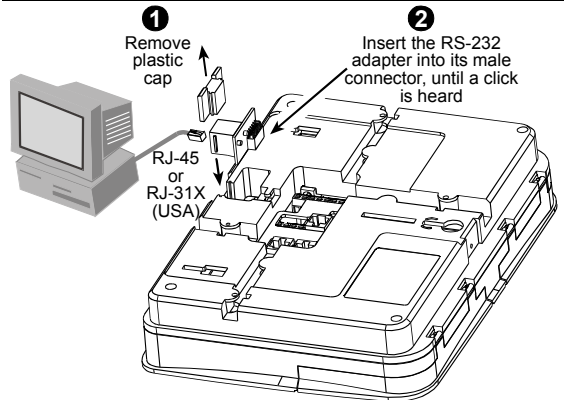


Figure 3.4 - Connecting the PowerMax+ to a Computer

### 3.9 Connecting PowerMax+ to GSM Modem

The GSM unit enables the PowerMax+ system to operate over cellular network. For details regarding the GSM modem features and connections, refer to the GSM Modem installation instructions.

## 4. PROGRAMMING

### 4.1 INTRODUCTION

#### 4.1.1 General Guidance

We recommend to program the PowerMax+ on the work bench before actual installation. Operating power may be obtained from the backup battery or from the AC power supply.

The installer's menu is accessible only to those who know the installer's 4-digit code, which is **9999** by factory default.

For PowerMax+ that has 2 installer codes, the default INSTALLER code is **8888** and the default MASTER INSTALLER code is **9999**.

The following actions can be done only by using the master installer code:

- Changing master installer code.
- Resetting the PowerMax+ parameters to the default parameters,
- Defining specific communication parameters, as detailed in a note in figure 4.5.

Obviously, you are expected to use this code only once for gaining initial access, and replace it with a secret code known only to yourself.

You will mainly use 5 control pushbuttons during the entire programming process:

	- to move one step forward in a menu.
	- to move one step backward in a menu.
	- to enter the relevant menu or confirm data.
	- to move one level up in a menu.
	- to return to the "OK TO EXIT" state.

The sounds you will hear while programming are:

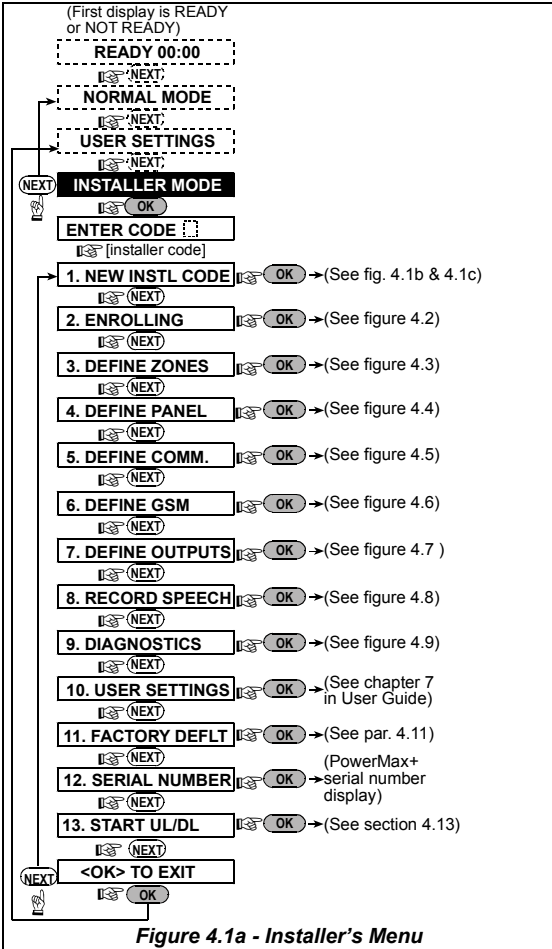
	- Single beep, heard whenever a key is pressed.
	- Double beep, indicates automatic return to the normal operating mode (by timeout).
	- Happy Melody (- - - —), indicates successful completion of an operation.
	- Sad Melody (— — —), indicates a wrong move or rejection.

### 4.1.2 Entering an Invalid Installer Code

If you enter an invalid installer code 5 times, the keypad will be automatically disabled for 30 seconds.

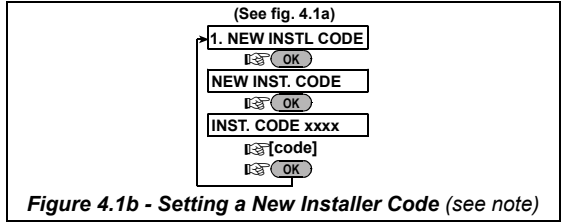
### 4.1.3 Installer's Menu

The installer's menu is shown in figure 4.1a. The text in rectangles represents the current PowerMax+ display.



### 4.1.4 Setting a New Installer Code

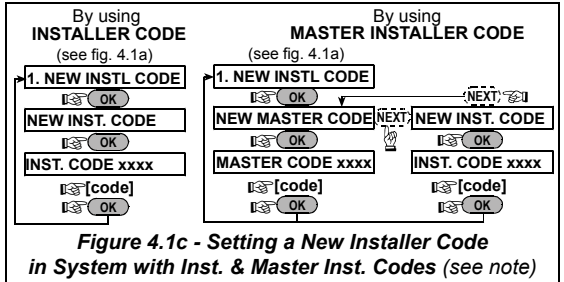
To set an installer code, perform the actions that are presented in figure 4.1b. When you are instructed to enter code, enter a 4-digit code.



### 4.1.5 Setting a New Installer Code in PowerMax+ that has 2 Installer Codes

For PowerMax+ with 2 installer codes, INSTALLER code (default 8888) and MASTER INSTALLER code (default 9999), set new codes as shown in figure 4.1c.

By using the master installer code, the menu enables changing both master installer code and installer code. By using the installer code, the menu enables changing the installer code only.



**Note:** If a code is defined as "0000" it will not enable the code holder to enter the installer menu in future!

## 4.2 ENROLLING WIRELESS DEVICES AND KEYFOB TRANSMITTERS

### 4.2.1 General Guidance

The ENROLLING mode has 5 sub-modes:

- ENROLLING TYPE (wireless devices)
- ENROLL WL (wireless devices) DEVICE
- ENROLL KEYFOB (multi-button CodeSecure transmitters)
- ENROLL WL 1WAY KP (wireless commander MCM-140+)
- ENROLL WL SIREN (wireless siren)

Before beginning, gather all the devices that you intend to

enroll and make sure they all have batteries installed.

Your control panel must recognize the unique identification code (ID) of each such device in order to supervise them, receive their signals and respond accordingly.

**Attention!** CodeSecure transmitters are mainly used for arming/disarming and can not be enrolled to zones. For enrolling to zones, use only non-CodeSecure wireless devices.

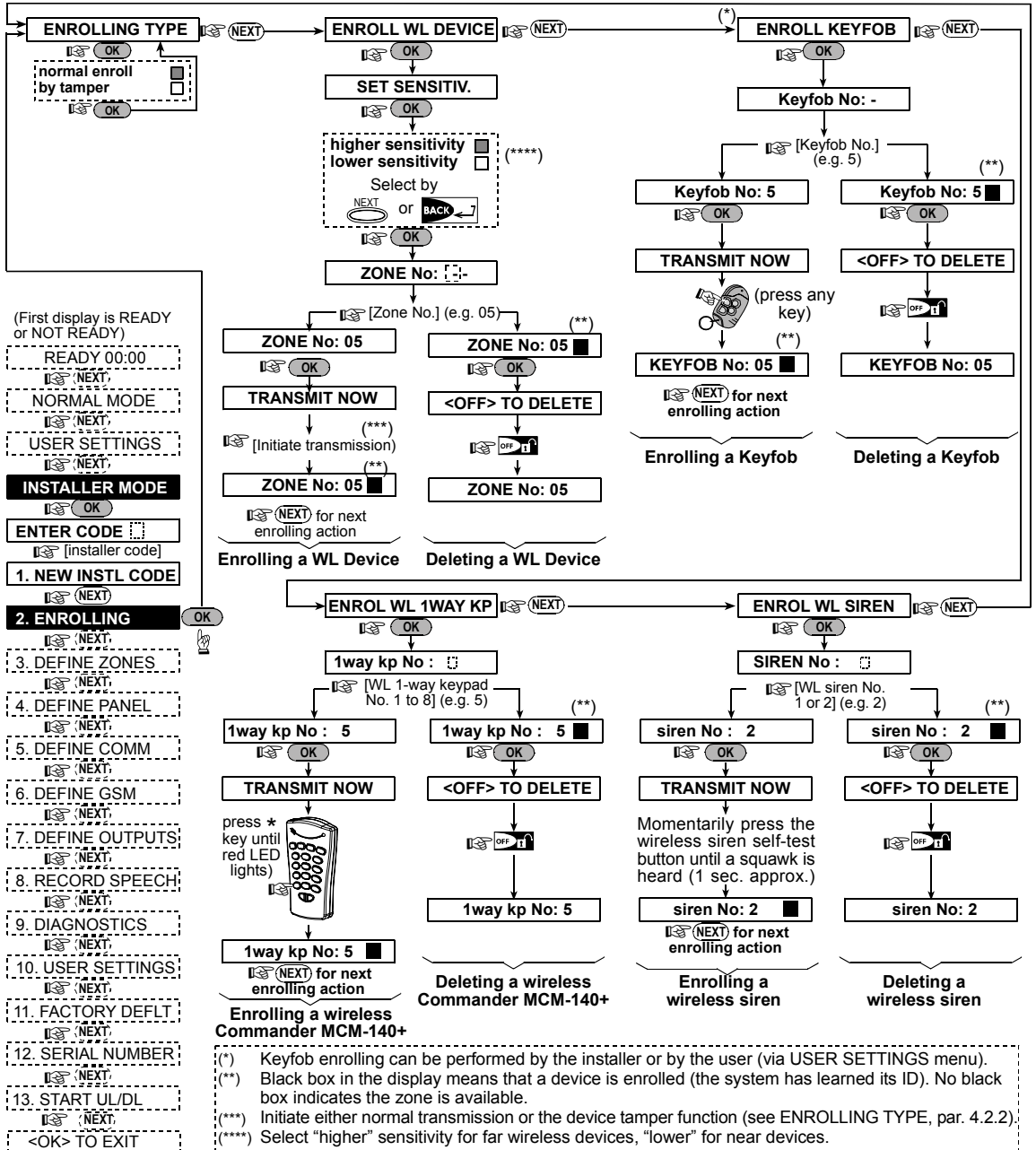


Figure 4.2 - Enrolling / Deleting Wireless Devices / Keyfobs / Wireless Commanders / Wireless Sirens

## 4.2.2 Enrolling Type

Here you determine whether wireless devices enrolling can be performed by normal transmission, or by device Tamper function (opening its cover). Available options: normal, or by tamper.

## 4.2.3 Enroll/Delete Wireless Devices

Wireless devices include various wireless PowerCode detectors and hand-held special-task transmitters.



- Before enrolling, the lens at the front of PIR and dual-technology sensors should be masked to prevent inadvertent transmission.
- Make sure that magnetic contact transmitters are together with their magnets, to prevent them from sending out alarm transmissions.

To enroll / delete wireless devices, refer to figure 4.2.

## 4.2.4 Enroll/Delete Keyfob Transmitters

Keyfob transmitters are multi-button wireless CodeSecure™ transmitters. Eight system users use them for better, quicker and safer control over various system functions.

**Note:** For UL installations, if MCT-234 keyfob is used the PowerMax+ voice/speaker shall be enabled.

To enroll / delete keyfob transmitters, refer to figure 4.2.

## 4.2.5 Enroll/Delete Wireless Commander

The Wireless commander is a remote control unit that enables the user to remotely control the system. To enroll / delete up to 8 wireless commanders, refer to figure 4.2 (Enroll WL 1-way KP).

## 4.2.6 Enroll/Delete Wireless Siren

The wireless siren is a remote siren that is activated upon predefined events by the PowerMax+ system. To enroll / delete up to 2 wireless sirens, refer to figure 4.2.

## 4.3 DEFINING ZONE TYPES, NAMES & CHIME ZONES

This mode allows you to assign one of 12 zone types to each of the system 30 (wireless & wired) zones. In addition, it also allows you to assign a name to each zone and determine whether the zone will operate as a chime zone while the system is in the disarmed or Home arming state. When a chime zone is triggered, chime melody or zone name is heard (there are 3 selectable chime modes - Melody chime, Zone Name Chime or Chime off).

A list of factory defaults is printed on table 1. You may fill out the blank columns even before you start and proceed to program according to your own list.

### Remember!

A delay zone is also a perimeter zone by definition.

**Zone types are fully explained in Appendix D.**

**For UL installations, hard wired zones are not intended to be used as FIRE zones.**

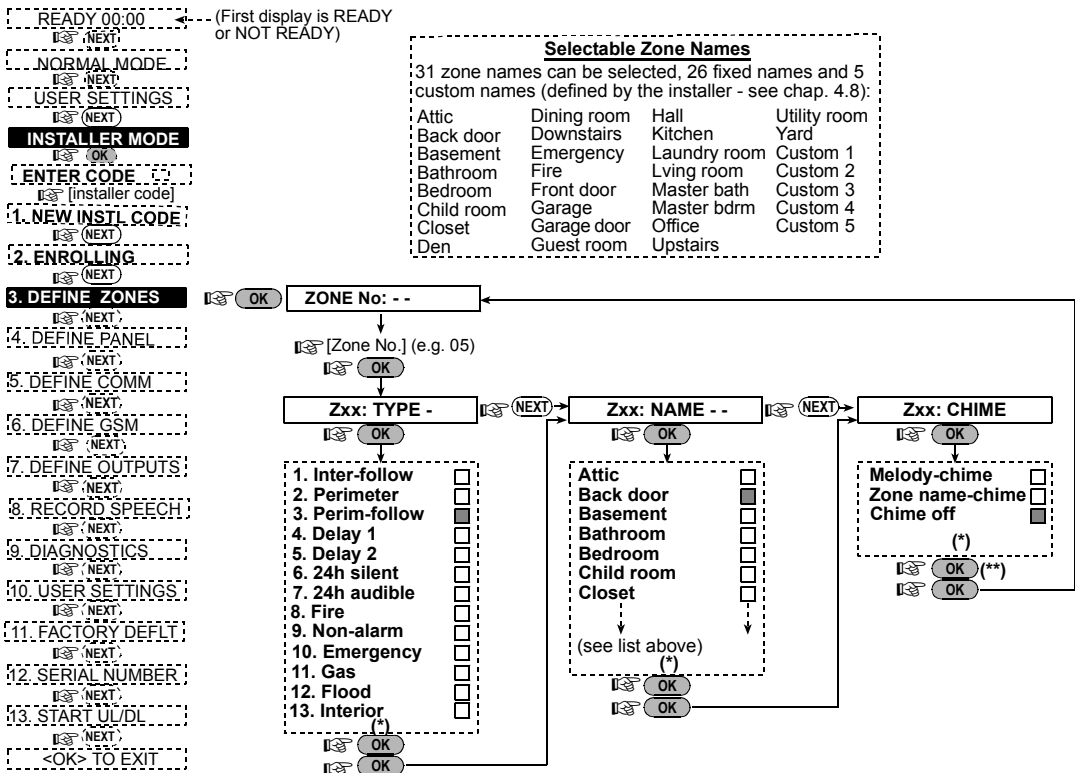


Figure 4.3 - DEFINE ZONES Flow Chart

\* The currently saved option is displayed with a dark box at the right side. To review the options, repeatedly click or button, until the desired option is displayed, then click (a dark box will be displayed at the right side).

\*\* Clicking the in this location brings you to the same zone number that you are dealing with. Press or to select the next zone.

Table 1 - DEFAULT AND PROGRAMMED ZONE DEFINITIONS

Zone No.	Zone Type		Zone Name		Chime (melody Zone Name or Off) (*)
	Default	Programmed	Default	Programmed	
1	Delay 1		Front Door		
2	Delay 1		Garage		
3	Delay 2		Garage Door		
4	Perimeter		Back Door		
5	Perimeter		Child Room		
6	Interior		Office		
7	Interior		Dining Room		
8	Perimeter		Dining Room		
9	Perimeter		Kitchen		
10	Perimeter		Living Room		
11	Interior		Living Room		
12	Interior		Bedroom		
13	Perimeter		Bedroom		
14	Perimeter		Guest Room		
15	Interior		Master Bedroom		
16	Perimeter		Master Bedroom		
17	Perimeter		Laundry Room		
18	Perimeter		Master Bathroom		
19	Perimeter		Basement		
20	Fire		Fire		
21	Fire		Fire		
22	Emergency		Emergency		
23	Emergency		Emergency		
24	24 h / silent		Basement		
25	24 h / silent		Office		
26	24 h / audible		Attic		
27	24 h / audible		Den		
28	non-alarm		Yard		
29	non-alarm		Hall		
30	non-alarm		Utility room		

\* **Note:** All zones are Off-chime by default. Enter your own choice in the last column and program accordingly.

## 4.4 DEFINING CONTROL PANEL PARAMETERS

### 4.4.1 Preliminary Guidance

This mode allows you to customize the control panel and adapt its characteristics and behavior to the requirements of the particular user. An illustrated process is shown in figure 4.4. In this illustration, each selected option is displayed with a dark box at the right side. To review the options, repeatedly click NEXT or BACK button, until the desired option is displayed, then click SHOW/OK button.

### 4.4.2 Entry Delays 1&2 (fig. 4.4, location 01, 02)

Two different entry delays allow the user to enter the protected site (while the system is in the armed state) via 2 specific doors and routes without causing an alarm.

Following entry, the user must disarm the control panel before the entry delay expires. Slow-rate warning beeps start sounding once the door is opened, until the last 10 seconds of the delay, during which the beeping rate increases. Locations No. 1 (entry delay 1) and 2 (entry delay 2) allow you to program the length of these delays. Available options for each delay are: **00s, 15s, 30s, 45s, 60s, 3m and 4m.**

**In UL installations, these delays must be 45 s max.**

### 4.4.3 Exit Delay (fig. 4.4 location 03)

An exit delay allows the user to arm the system and leave the protected site via specific routes and doors without causing an alarm. Slow-rate warning beeps start sounding once the arming command has been given, until the last 10 seconds of the delay, during which the beeping rate increases.

Location No. 3 allows programming of the exit delay length. Available options are: **30s, 60s, 90s, 120s, 3m, 4m.**

### 4.4.4 Bell Time (fig. 4.4, location 04)

Here you select the length of time the bell (or siren) is allowed to function upon alarm. The bell time starts upon activation of the siren. Once the bell time expires, the siren is automatically shut down.

Available options: **1, 3, 4, 8, 10, 15 and 20 minutes.**

**In UL installations, set bell time to 4 minutes minimum.**

### 4.4.5 Abort Time (fig. 4.4 location 05)

Here you select the length of time allowed by the system to abort an alarm (not applicable to alarms from FIRE, 24H SILENT and EMERGENCY zones). The PowerMax+ is programmed to provide an "abort interval" that starts upon detection of an event. During this interval, the buzzer sounds a warning but the siren remains inactive and the alarm is not reported. If the user disarms the system within the allowed abort interval, the alarm is aborted.

Available options: **00s, 15s, 30s, 45s, 60s, 2m, 3m, 4m.**

### 4.4.6 Alarm Cancel (fig. 4.4, location 06)

Here you determine the "cancel alarm" period that starts upon reporting an alarm to the central station. If the user disarms the system within that time period, a "cancel alarm" message is sent to the central station.

The options are: **1, 5, 15, 60 minutes, 4 hours and also cancel inactive.**

#### 4.4.7 Quick Arm (fig. 4.4, location 07)

Here you determine whether the user will be allowed to perform quick arming or not. Once quick arming is permitted, the control panel does not request a user code before it arms the system.

The two options are: **quick arm ON** and **quick arm OFF**.

#### 4.4.8 Bypass (fig. 4.4, location 08)

Here you permit either manual bypassing of individual zones (through the USER SETTINGS menu), or allow the system to "force arm" (perform automatic bypassing) of open zones during the exit delay. If desired, press the arming key twice if you want to eliminate the delay beeps that continue during a force arming. If a zone is open and forced arming is not permitted, "NOT READY" is displayed and the system does not arm (the "Sad Melody" will sound). If "no bypass" is selected, neither manual bypassing nor force arming is allowed.

Options: **manual bypass**, **force arm** and **no bypass**.

**In UL installations, "force arm" must not be selected.**

#### 4.4.9 Exit Mode (fig. 4.4, location 09)

Here you determine whether the exit delay will restart if the exit / entry door is reopened before the exit delay expires. Restarting the exit delay is helpful if the user re-enters immediately after going out to retrieve an item that he left behind. Three types of exit mode are available:

**Restart Exit** - Exit delay restarts when the door is reopened during exit delay. The restart occurs once only.

**Off by door** - When the door is closed, the exit delay is automatically terminated (even if the defined exit delay was not completed).

**Normal** - The exit delay is exactly as defined, regardless of whether the door is open or closed.

**In UL installations, "normal" must be selected.**

#### 4.4.10 Piezo Beeps (fig. 4.4, location 10)

Here you determine whether warning beeps will sound or muted during exit and entry delays. An additional option is to mute the warning beeps only when the system is armed "HOME".

Options: **enable beeps**, **off when home** and **disable beeps**.

#### 4.4.11 Trouble Beeps (fig. 4.4, location 11)

Under trouble conditions, the sounder emits a series of 3 short beeps once per minute. Here you determine whether this special beeping sequence will be active, inactive, or just inactive at night (the range of "night" hours is defined in the factory). The 3 options are: **enable beeps**, **off at night (8 PM through 7 AM)** and **disable beeps**.

#### 4.4.12 Panic Alarm (fig. 4.4, location 12)

Here you determine whether the user will be allowed to initiate a panic alarm by simultaneous pressing either the two panic buttons (on the keypad / wireless commander) or away + home (on a keyfob transmitter). Audible panic activates the siren and simultaneously transmits a message via telephone. Silent panic only transmits a message via telephone. The options are: **silent panic**, **audible panic** and **disable panic**.

#### 4.4.13 Swinger Stop (fig. 4.4, location 13)

Here you determine how many times each zone is allowed to initiate an alarm within a single arming period (including tamper & power failure events of detectors, PowerMax+ and wireless siren). If the alarms number from a specific zone exceeds the programmed number, the control panel automatically bypasses the zone to prevent recurrent siren noise and nuisance reporting to the central station. The zone will be reactivated upon disarming, or 48 hours after having been bypassed (if the system remains armed).

The available options are: **shut after 1**, **shut after 2**, **shut after 3** and **no shutdown**.

**In UL installations, No Shutdown must be selected.**

#### 4.4.14 Cross Zoning (fig. 4.4, location 14)

Here you determine whether cross zoning will be active or inactive. Cross zoning is a method used to counteract false alarms - an alarm will not be initiated unless two adjacent zones are violated within a 30-second time limit. This feature is active only when arming AWAY and only with zone couples from zone No. 18 to 27 (18 and 19, 20 and 21, etc.). You may use any one of these zone couples to create a "cross-zoned" area.

**Note:** *If one of two crossed zones is bypassed (see Para. 4.4.8), the remaining zone will function independently.*

**Note:** *Every 2 crossed zones must be of the allowed zone type (Interior, Perimeter, Perimeter follower).*

The options are: **cross zone ON** and **cross zone OFF**.

**Cross zoning is not applicable in Entry/ Exit zones and 24h zones (Fire, Emergency, 24h audible, 24h silent).**

#### 4.4.15 Supervision (fig. 4.4, location 15)

Here you determine the time limit for reception of supervision reports from various supervised wireless devices. If any device does not report at least once within the selected time limit, an "INACTIVITY" alert is initiated.

The options are: **1, 2, 4, 8, 12 hours** and **disable**.

**In UL installations, the interval must not exceed 4 h and shall not be disabled.**

#### 4.4.16 NOT READY (fig. 4.4, location 16)

Here you determine if the system will be NOT READY status when there is a supervision failure. In the "in supervision" mode, the system will be in NOT READY status if during the last 20 minutes a supervision message was not received. Options: **normal** and **in supervision**.

#### 4.4.17 AUX Button (fig. 4.4, location 17)

Here you select the function of the AUX button on keyfob transmitters and wireless commanders MCM-140. Three options are offered:

**Status:** Pressing the AUX button will cause the control panel's voice module to announce the system status.

**Instant:** Pressing the AUX button while the exit delay is in progress will cause the system to arm "instant" (the entry delay is canceled).

**PGM / X-10:** Pressing the AUX button will activate the PGM output or X-10 units (see further programming under "DEFINE OUTPUTS", par. 4.7).

#### 4.4.18 Jam Detect (fig. 4.4, location 18)

Here you determine whether jamming (interfering transmissions, on the radio channel used by the system) will be detected and reported or not.

If a jam detection option is selected, the system does not allow arming under the relevant jamming conditions.

##### Jam Detection Options

Option	Detection and Reporting when
<b>UL (20/20)</b> (USA standard)	There is continuous 20 seconds of jamming
<b>EN (30/60)</b> (Europe standard)	There is an accumulated 30 seconds of jamming within 60 sec.
<b>class 6 (30/60)</b> (British standard)	Like EN (30/60) but the event will be reported only if the jamming duration exceeds 5 minutes.
<b>Disabled</b>	(no jamming detection and reporting).

#### 4.4.19 Latchkey (fig. 4.4, location 19)

Here you determine whether the system can be armed in the latchkey mode. If the system is armed this way, a "latchkey" message will be sent to specific telephones upon disarming by a "latchkey user" (users 5-8 or keyfob transmitters 5-8). This mode is useful when parents at work want to be informed of a child's return from school. You can record a name for latchkey users.

The options are: **Latchkey ON** and **Latchkey OFF**.

**In UL installations, this function shall not be used.**

#### 4.4.20 “Not Active” (fig. 4.4, location 20)

Here you determine the time limit for reception of signals from sensors used to monitor the activity of sick, elderly or disabled people. If no device detects and reports movement at least once within the defined time limit, a “not-active” alert is initiated.

Options: **3, 6, 12, 24, 48, 72 hours** and **no act disable**.

#### 4.4.21 Back Light (fig. 4.4, location 21)

Here you determine whether the keypad back lighting will remain on at all times or will come on when a key is pressed and go off within 10 seconds if no further keystrokes are sensed.

The two options are: **always on** and **off after 10 s**.

**In UL installations, “off after 10 s” must be selected to save battery power.**

#### 4.4.22 Duress (fig. 4.4, loc. 22)

A duress alarm (ambush) message can be sent to the central station if the user is forced to disarm the system under violence or menace. To initiate a duress message, the user must disarm the system with the duress code (2580 by default). Here you can change the code digits or enter “0000” to disable the duress feature. **The system does not allow the user to program the duress code saved in this memory location as an existing user code.**

#### 4.4.23 Piezo Siren (fig. 4.4, location 23)

Here you determine whether the internal siren will sound or remain silent upon alarm (according to the user preference). Options: **piezo siren on, piezo siren off**.

**In UL installations, the piezo siren must be ON.**

#### 4.4.24 Reset Option (fig. 4.4, location 24)

Here you determine whether the system can be rearmed (after an event) by the user or only by the installer.

Options: **user reset** or **engineer reset**.

If Engineer Reset is selected, the system can be rearmed only by the installer; by entering and exiting the installer menu, by entering and exiting the event log (see page 24), or by remote telephone. To perform Engineer Reset via the telephone, establish communication with the PowerMax+ (see user guide, par. 6.3A, steps 1-5) and continue as follows:

- [\*], [installer code], [#]
- Wait for 2 beeps
- [\*], [1], [#]
- [\*], [99], [#]

#### 4.4.25 Tamper Option (fig. 4.4, location 25)

Here you determine whether zone tamper will be reported or ignored. The available options are: **zone tamper ON** and **zone tamper OFF**.

#### 4.4.26 Siren On Line (fig. 4.4, location 26)

Here you determine whether the siren will be activated or not when the telephone line fails during system armed state. Available options are: **enable on fail, disable on fail**.

#### 4.4.27 Memory Prompt (fig. 4.4, location 27)

Here you determine whether the user will receive indication that an alarm has been activated.

The available options are: **enable** and **disable**.

#### 4.4.28 Disarm Option (fig. 4.4, location 28)

Here you determine when it is possible to disarm the system:

- Any time.
- During entry delay, by using the PowerMax+ keypad or wireless device (keyfob).
- During entry delay, by using a wireless device (keyfob) only.
- During entry delay, or by using the PowerMax keypad in AWAY mode.

Options: **any time, on entry all, on entry wireless, or entry + away kp**.

#### 4.4.29 Bell/Rep. Option (fig. 4.4, location 29)

Here you determine whether an alarm will be initiated (siren / report) when there is a supervision / jamming failure during AWAY arming state.

The available options are: **EN standard** and **other**. When “EN standard” is selected, if there is supervision / jamming failure during AWAY arming, the siren is activated and the events are reported as tamper events. When “Other” is selected, there is no such activity during AWAY arming.

#### 4.4.30 Low-Bat Ack (fig. 4.4, location 30)

Here you determine whether the user will hear or will not hear low battery sound when he tries to disarm the system with a keyfob whose battery voltage is low.

Available options are: **keyfob L-B on** (the user has to acknowledge the keyfob low battery message) or **keyfob L-B off** (the user does not have to acknowledge the keyfob low battery message).

#### 4.4.31 Screen Saver (fig. 4.4, location 31)

Here you can determine that if no key is pressed during more than 30 seconds, the display will be “PowerMax” and the LEDs will not light (to prevent possible intruder of knowing the system status). You can determine that normal display will return after pressing the OFF button followed by entering user code (**Refresh by Code**) or after pressing any key (**Refresh by Key**).

If **Refresh by Key** is selected, the first pressing of any key (except Fire and Emergency) will cause normal display return and the second press will perform the key function. Regarding the Fire and Emergency keys, the first key press will cause normal display return and also will perform the Fire/Emergency function.

Options: **scrn saver OFF, refresh by code, refresh by key**.

#### 4.4.32 Confirm Alarm (fig. 4.4, location 32)

Here you determine that if 2 successive alarms will occur during a specific period, the second alarm will be considered as a **confirmed alarm** (for confirmed alarm reporting, see par. 4.5.12 REPORT CNF ALARM).

Options: **disable 30 min., 45 min., 60 min., or 90 min.**

#### 4.4.33 AC FAIL REP (fig. 4.4, location 33)

Here you determine the time interval between AC power failure occurrence and the failure reporting. Options: **5 minutes, 30 minutes, 60 minutes** or **180 minutes**.

#### 4.4.35 User Permission (fig. 4.4, location 35)

Here you determine whether the access to the INSTALLER MODE requires user permission. If you select ENABLE, the installer mode will be accessible only through the user menu after entering the user code.

Options: **Enable, Disable**.



## 4.5 DEFINING COMMUNICATION PARAMETERS

### Preliminary Guidance




This mode allows you to adapt the telephone communication parameters to the local requirements.

**Note:** For all UL-certified systems, it is up to the installer to completely verify the compatibility between the DACT format and the receivers.

**Compatible central station receivers are:**  
Osborne-Hoffman model 2000, Ademco Model 685, FBII Model CP220, Radionics Model D6500, Sur-Gard Model SG-MLR2-DG and Silent Knight Model 9500.

**IMPORTANT:** In telephone / pager number locations and account number locations, you may be required to enter hexadecimal digits. In telephone number locations, these digits are used as codes to control the dialer:

Hex. Digit	Keying Sequence	Code Significance
A	<#> ⇒ <0>	Applicable <i>only</i> at the beginning of a number - the dialer waits 10 seconds or waits for dial tone, whichever comes first and then dials.
B	<#> ⇒ <1>	Inserts an asterisk (*)
C	<#> ⇒ <2>	Inserts a pound sign (#)
D	<#> ⇒ <3>	Applicable <i>only</i> at the beginning of a number - the dialer waits 5 seconds for dial tone and goes on hook if none is received.
E	<#> ⇒ <4>	Applicable <i>only</i> in the middle of the number - the dialer waits 5 seconds
F	<#> ⇒ <5>	Not applicable in phone numbers

To enter a series of digits, use the following keys:  
<Numeric keypad> - to enter the number  
 - moves the cursor from left to right  
 - moves the cursor from right to left  
 - deletes everything after the cursor (to the right).

#### 4.5.1 Autotest Time (fig. 4.5, location 01)

Here you determine the time at which the telephone line will be tested and reported to the central station.

#### 4.5.2 Autotest Cycle (fig. 4.5, location 02)

Here you determine the time interval between consecutive telephone line test messages sent to the central station. The control panel performs this at regular intervals to verify proper communications.

The options are: **test every 1, 5, 7, 14, 30 days** and **test off**.

#### 4.5.3 Area Code (fig. 4.5, location 03)

Here you enter the system tel. area code (up to 4 digits).

#### 4.5.4 Out Access No (fig. 4.5, location 04)

Here you enter the number that is used as a prefix to access an outside telephone line (if exists).

#### 4.5.5 First Central Station Tel. (fig. 4.5, loc. 05)

Here you program telephone number of the 1<sup>st</sup> central station (including area code, 16 digit max) to which the system will report the event groups defined in memory location 11 (see note in fig. 4.5).

#### 4.5.6 First Account No. (fig. 4.5, location 06)

Here you enter number that will identify your specific alarm control system to the first central station. The number consists of 4 or 6 hexadecimal digits (see note in fig. 4.5).

#### 4.5.7 2<sup>ND</sup> Central Station Tel. (fig. 4.5, loc. 07)

Here you program telephone number of the 2<sup>nd</sup> central station (including area code, 16 digit max) to which the system will report the event groups defined in memory location 11 (see note in fig. 4.5).

#### 4.5.8 Second Account No. (fig. 4.5, loc. 08)

Here you enter number that will identify your system to the 2<sup>nd</sup> central station. The account number consists of 4 or 6 hexadecimal digits (see note in fig. 4.5).

#### 4.5.9 Report Format (fig. 4.5, location 09)

Here you select the reporting format used by the control panel to report events to central stations (see note in figure 4.5).

The options are: **Contact-ID** **SIA** **4/2 1900/1400** **4/2 1800/2300** **Scancom** (see Appendix C - code lists).

#### 4.5.10 4/2 Pulse Rate (fig. 4.5, location 10)

Here you select the pulse rate at which data will be sent to central stations if any one of the 4/2 formats has been selected in Location 09 REPORT FORMAT (see note in fig. 4.5). The options are: **10, 20, 33** and **40** pps.

#### 4.5.11 Reporting to Central Stations

(fig. 4.5, location 11) (see note in fig. 4.5).

Here you determine which types of event will be reported to central stations. Due to lack of space in the display, abbreviations are used: alarm is "alarm", alert is "alrt" and open/close is "o/c". The asterisk (\*) is a separator between events reported to **central station 1** and events reported to **central station 2**.

Messages are divided by type into three groups:

#### GROUP EVENTS REPORTED

**Alarms** Fire, Burglary, Panic, Tamper  
**Open/Close** Arming AWAY, Arming HOME, Disarming  
**Alerts** No-activity, Emergency, Latchkey  
 "Alarm" group has the highest priority and "Alert" group has the lowest priority.

The selectable options are as follows:

Plan name	Sent to center 1	Sent to center 2
all -o/c * backup	All but open/close	All if cent. 1 doesn't respond
all * all	All	All
all -o/c * all -o/c	All but open/close	All but open/close
all -o/c * o/c	All but open/close	Open/close
all (-alrt) * alrt	All but alerts	Alerts
Alarm * all (-alarm)	Alarms	All but alarms
Disable report	Nothing	Nothing
all * backup	All	All if cent. 1 doesn't respond

**Note:** "All" means that all 3 groups are reported and also trouble messages - sensor / system low battery, sensor inactivity, power failure, jamming, communication failure etc.

#### 4.5.12 Report CNF Alarm (fig. 4.5, location 12)

Here you determine whether the system will report whenever 2 or more events (**confirmed alarm**) occur during a specific period (see par. 4.4.32 and note in figure 4.5).

Available options are: **enable report**, **disable report**, **enable + bypass** (enabling report and bypassing the detector - applicable to PowerMax+ that is compatible with DD423 standard).

#### 4.5.13 Send 2WV Code (fig. 4.5, location 13)

Here you determine whether the system will send two-way voice code to the central station (to turn the central station from data communication to voice communication state) by using pre-selected SIA or Contact-ID communication format only (see note in fig. 4.5). Options: **send** and **don't send**.

#### 4.5.14 Two-Way Voice Central Stations

(fig. 4.5, loc. 14). (See note in fig. 4.5).

Here you select the timeout for 2-way voice communication with Central Stations, or enable the central station to ring back for 2-way voice function. This option is applicable only after reporting an event to the central station. (The central station person can press [3] for listen-in, [1] for "speak out" or [6] for listening and speaking).

The options are: **10, 45, 60, 90 seconds, 2 minutes, ring back** and **disable** (no two-way voice communication).

**In UL installations, this function must be disabled.**

**Note:** If "Ring Back" is selected, you should select "Disable Report" for private telephone (see par. 4.5.20 - Reporting to Private Telephones), otherwise the central station will establish communication with the PowerMax+ (after an event occurrence) in the normal manner (and not after one ring).

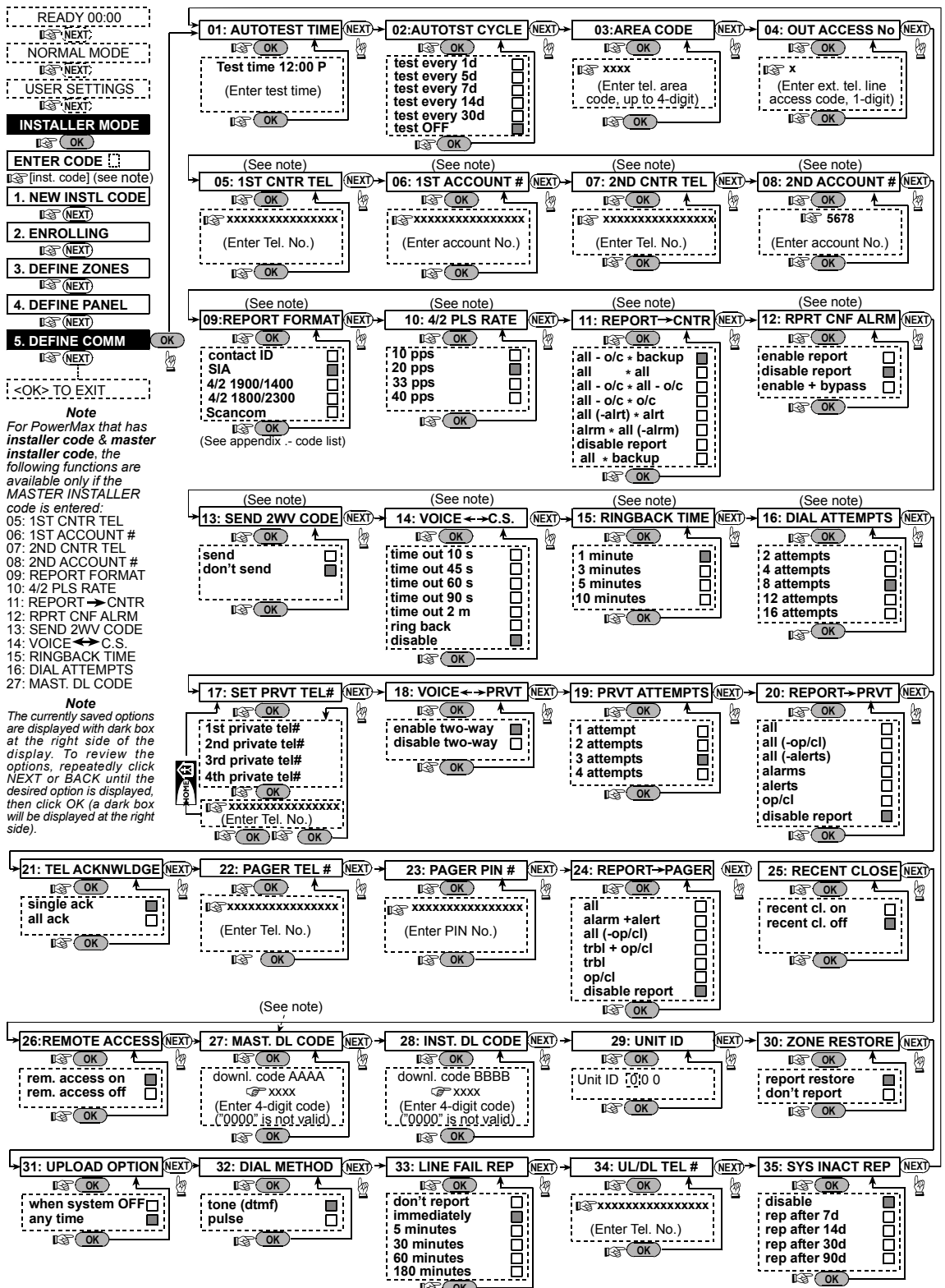


Figure 4.5 - DEFINE COMM Flow Chart

#### 4.5.15 Ring Back Time (fig. 4.5, location 15)

Here you determine the period during which the central station can establish 2-way voice communication with the PowerMax+ (after 1 ring), if:

A. Alarm type message was received by central station.

B. Ring Back function was selected (see par. 4.5.14).

The options are: **1, 3, 5 or 10 min.** (see note in fig. 4.5).

#### 4.5.16 Dialing Attempts (fig. 4.5, location 16)

Here you determine how many times the communicator will dial the central station's number. (see note in fig. 4.5).

The options are: **2, 4, 8, 12, and 16 attempts.**

**Attention!** A maximum of 2 dialing attempts is permitted by the Australian Telecommunication Authority.

**In UL installations, dialing attempts should be set to 8.**

#### 4.5.17 Set Private Tel. No. (fig. 4.5, location 17)

Here you program the four telephone numbers (including area code) of the private subscriber to which the system will report the event groups defined in Location 20.

#### 4.5.18 Two-Way Voice - Private Phones (fig. 4.5, location 18)

Here you determine whether 2-way voice communication with private telephones will be allowed or not.

The two options are: **enable 2-way** and **disable 2-way.**

**In UL installations, this function must be disabled.**

#### 4.5.19 Private Tel. Dialing Attempts (fig. 4.5, location 19)

Here you determine how many times the communicator will dial the called party's number (private telephone).

The options are: **1, 2, 3 and 4 attempts.**

**Attention!** A maximum of 2 dialing attempts is permitted by the Australian Telecommunication Authority.

#### 4.5.20 Reporting to Private Telephones (fig. 4.5, location 20)

Here you determine which event groups will be reported to private telephone subscribers. The options are as follows:

Term	Description
all	All messages
all (-op/cl)	All messages, except open/close
all (-alerts)	All messages, except alerts
alarms	Alarm messages
alerts	Alert messages
op/cl	Open/close
disable report	No message will be reported

**Note:** "All" means all events including the L. BAT and AC FAIL trouble messages.

#### 4.5.21 Tel. Acknowledge (fig. 4.5, location 21)

Here you determine whether the system will use the single acknowledge or the all acknowledge mode when reporting to private telephones.

**Note:** In the single acknowledge mode, receiving an acknowledge signal from a single telephone is sufficient to consider the current event closed and call off the communication session. The remaining telephones serve for backup purposes only. In the all acknowledge mode, an acknowledge signal must be received from each telephone before the current event is considered reported.

The options are: **single ack** and **all ack**

#### 4.5.22 Pager Tel. No. (fig. 4.5, location 22)

Here you program the telephone number (including area code) of the pager to which the system will report (if any).

#### 4.5.23 Pager's PIN No. (fig. 4.5, location 23)

Here you enter the pager's PIN code - a digital sequence that is the pager's address. The paging company's computer needs this input for routing messages to the

specific pager. The PIN sequence precedes any digital message that the PowerMax+ sends to the pager to report an event. It may include digits, pauses and special characters (\* or #). Call the paging company to find out what the pager's PIN code should consist of.

**Important!** In this location, special characters can be entered as shown below:

To Insert	Keying Sequence	Character Displayed
*	<#> => <1>	B
#	<#> => <2>	C
5 sec pause	<#> => <3>	E

Enter the pager's PIN number (up to 16 digits, including special characters, depending on pager system protocol).

#### 4.5.24 Reporting to a Pager (fig. 4.5, loc. 24)

Here you determine which event groups will be reported to the pager. (For the abbreviations, refer to par. 4.5.11).

The options are: **all** **alarms + alerts** **all (- op/cl)** **trbl + op/cl** **trbl** **op/cl** **disable report**

#### 4.5.25 Recent Closure (fig. 4.5, location 25)

Here you enable or disable the "recent closing" report, that is sent to the central station if an alarm occurs within 2 minutes from the expiry of the exit delay.

The options are: **recent close ON** and **recent close OFF.**

#### 4.5.26 Remote Access (fig. 4.5, location 26)

Here you give or deny permission to access the system and exercise control from a remote telephone.

The options are: **rem. access ON** and **rem. access OFF.**

#### 4.5.27 Mast. DL Code (fig. 4.5, location 27)

Here you determine the master installer 4-digit password for downloading/uploading data into/from the PowerMax+ memory. (See note in fig. 4.5).

**Attention!** If "0000" is used, it will not enable connection of the PowerMax+ to the PC for upload/download purpose.

#### 4.5.28 Inst. DL Code (fig. 4.5, location 28)

Here you determine the installer 4-digit password for downloading data into the PowerMax+ memory.

**Attention!** If "0000" is used, it will not enable connection of the PowerMax+ to the PC for upload/download purpose.

#### 4.5.29 Unit ID (fig. 4.5, location 29)

(For future use - identification code for PowerMax+ system that is connected with several systems in a network).

#### 4.5.30 Zone Restore (fig. 4.5, location 30)

Here you determine whether a zone restore will be reported or not. Options: **report restore** and **don't report.**

#### 4.5.31 Upload Option (fig. 4.5, location 31)

Here you determine whether the PowerMax+ data can be uploaded into a computer while the system is in disarm state or any time (in HOME/AWAY arming & disarm state). The options are: **when system OFF** and **any time.**

#### 4.5.32 Dialing Method (fig. 4.5, location 32)

Here you determine the dialing method used by the automatic dialer built into the PowerMax+ control panel.

The options are: **Pulse** and **DTMF (tone).**

#### 4.5.33 Line Failure Report (fig. 5, loc. 33)

Here you determine if the telephone line disconnection will be reported or not and determine the delay between detection of line disconnection and the failure reporting. If the telephone line is disconnected, the message "tel line fail" will be stored in the event log.

The options are: **don't report, immediately, 5 minutes, 30 minutes, 60 minutes or 180 minutes.**

#### 4.5.34 UL/DL Tel. Number (fig. 4.5, loc. 34)

Here you enter the telephone number (up to 16 digits) of the UL/DL server.

#### 4.5.35 System Inactivity Report (fig. 4.5, loc. 35)

Here you determine whether the central station will receive a message if the system is inactive (not armed) during a defined period (days)

The options are: **disable, rep. after 7d, rep. after 14d, rep. after 30d, rep. after 90d.**

### 4.6 DEFINING GSM PARAMETERS

This mode is applicable only if your PowerMax+ is connected to the GSM unit. By using this mode, you can:

1. Define that the GSM unit is installed / not installed.
2. Define 4 private SMS phone numbers to which events will be reported.
3. Define which types of events will be reported to SMS phone numbers.
4. Define whether the GSM unit will serve as a backup for the regular telephone line, as a primary communication channel, as the only telephone channel or for sending SMS only.
5. Define whether GSM line failure will not be reported, or will be reported after 2/5/15/30 minutes.

An illustrated process is shown in figure 2.6. In this illustration, each selected option is displayed with a dark box at the right side. To review the options, repeatedly click NEXT or BACK button, until the desired option is displayed, then click SHOW/OK button.

#### 4.6.1 GSM Installation

Here you define whether the GSM unit is installed or not installed.

Available options are: **installed** or **not installed**.

#### 4.6.2 1st, 2nd, 3rd & 4th SMS Number

##### Number

Here you define the first, second, third and fourth SMS phone number (including area code, 16 digits maximum) to which pre-selected events types (see next paragraph) will be reported.

#### 4.6.3 Reporting to SMS Phone Number

Here you determine the types of events that will be reported to the pre-selected SMS phone numbers.

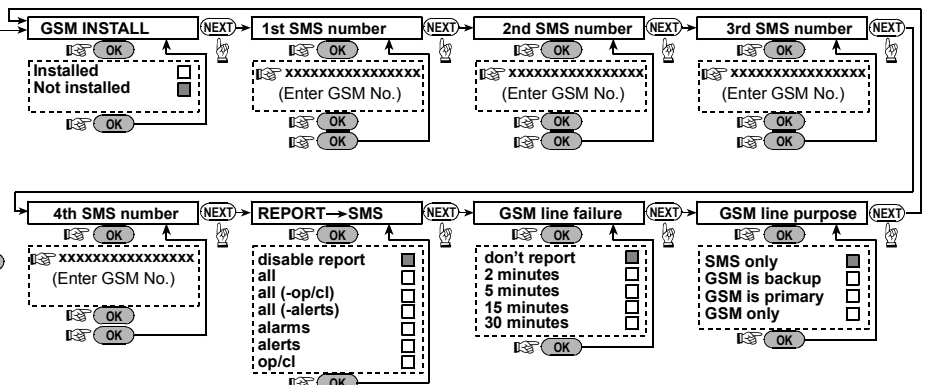
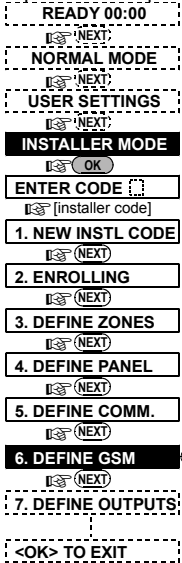


Figure 4.6 - DEFINE GSM

Event messages are divided by type into three groups:

GROUP	EVENTS REPORTED
Alarms	Fire, Burglary, Panic, Tamper
Open/Close	Arming AWAY, Arming HOME, Disarming
Alerts	No-activity, Emergency, Latchkey

The selectable options are detailed in the next table.

Option	Description
All	All event types
all (-op/cl)	All event types except open/close
all (-alerts)	All event types except alerts
Alarms	Alarms only
Alerts	Alerts only
op/CL	Open/close only
Disable report	No events reporting

**Note:** "All" means that all 3 groups are reported and also trouble messages - sensor / system low battery, sensor inactivity, power failure, jamming, communication failure etc.

#### 4.6.4 GSM Line Failure Reporting

Here you determine whether GSM network failure will be reported after 2 min., after 5 minutes, after 15 min., or after 30 minutes.

Available options: **don't report, 2 min, 5 min, 15 min, or 30 min.**

#### 4.6.5 GSM Line Purpose

Define whether the GSM unit will serve as a backup for the regular telephone line, as a primary communication channel or as the only telephone channel or for sending SMS only.

Available options are: **GSM is backup, GSM is primary or GSM only or SMS only.**

## 4.7 DEFINING OUTPUT PARAMETERS

### 4.7.1 Preliminary Guidance

This mode allows you:

- Events/conditions selection under which the PGM (programmable) output and fifteen "X-10" devices will function.
- Function type selection for every X-10 unit and for PGM output.
- General definitions selection for X-10 units
- Selection of the internal siren or STROBE light (that will be activated according to system programming).
- Enrolling 2-way X-10 units.

The process is shown in Fig. 4.7. Each selected option is displayed with a dark box at the right side. To review the options, repeatedly click NEXT or BACK button, until the desired option is displayed, then click SHOW/OK button.

### 4.7.2 Define PGM

For the PGM output, you can select **disable**, **turn on**, **turn off** or **pulse active** (turn on for predefined period, selected by **PULSE TIME**), as follows:

- **BY ARM AWAY** (upon AWAY arming).
- **BY ARM HOME** (upon HOME arming).
- **BY DISARM** (upon disarming).
- **BY MEMORY** (activated upon registration of an alarm in the memory, turned off upon memory clearing).
- **BY DELAY** (during exit / entry delays).
- **BY KEYFOB** (upon AUX button pressing in the keyfob transmitter / MCM-140+, if "PGM/X-10" is selected in "Define Panel" menu, location 17).
- **BY ZONES** (by disturbance in each of 3 selected zones, irrespective of arming / disarming). If you select **toggle**, the PGM output will be turned on upon event occurrence in these zones and will be turned off upon next event occurrence, alternately.
- **BY LINE FAIL**: PGM output is ON if telephone line is disconnected.

### 4.7.3 Defining INT/STRB

Here you determine if the INT output will be for site **internal siren** or for **strobe**.

### 4.7.4 X-10 GENERAL DEF

For X-10 devices, you can select the following actions:

- **FLASH ON ALARM** (you can select **no flash** or **all light flash**, to control X-10 lighting devices in alarm conditions).

- **TRBL INDICATION** (you can select **don't indicate** or **indicate** for X-10 failure indication by the TROUBLE LED).
- **FAIL REPORT** (You can select **report to central station 1**, **report to central station 2**, **report to pager**, **report to private telephone** and **send SMS**, for X-10 devices failure reporting).
- **3 PHASES & FREQ** (you can select **disable 3 phase**, **3 phase 50 Hz**, or **3 phase 60 Hz** to define the X-10 signal transmission type).
- **LOCKOUT TIME** (You can enter daytime limits between which X-10 lighting devices controlled by sensors will be off, even when the associated sensors are triggered).

**In UL installations, this function shall not be used.**

### 4.7.5 X-10 UNIT DEFINE

For the fifteen X-10 units you can perform the following programming actions:

- House code selection (a code letter from A to P that will distinguish the site in which the system is installed from other sites in the neighborhood).
- Specific number definition for every X-10 unit (01 – 15).
- Enrolling 1-way X-10 units
- Enrolling 2-way X-10 units (that can perform status reporting).

*Note: If a 2-way X-10 unit is installed without enrolling, interference to the 1-way X-10 units operation may occur.*

- For each X-10 unit you can select **disable**, **turn on**, **turn off** or **pulse active** (turn on for predefined period, selected by **PULSE TIME**), upon the following conditions:
  - **BY ARM AWAY** (upon AWAY arming).
  - **BY ARM HOME** (upon HOME arming).
  - **BY DISARM** (upon disarming).
  - **BY MEMORY** (activated upon registration of an alarm in the memory, turned off upon memory clearing).
  - **BY DELAY** (during exit / entry delays).
  - **BY KEYFOB** (upon AUX button pressing in the keyfob transmitter / MCM-140+, if "PGM/X-10" is selected in "Define Panel" menu, location 17).
  - **BY ZONES** (by disturbance in each of 3 selected zones, irrespective of arming / disarming). If you select **toggle**, the PGM output will be turned on upon event occurrence in these zones and will be turned off upon next event occurrence, alternately.

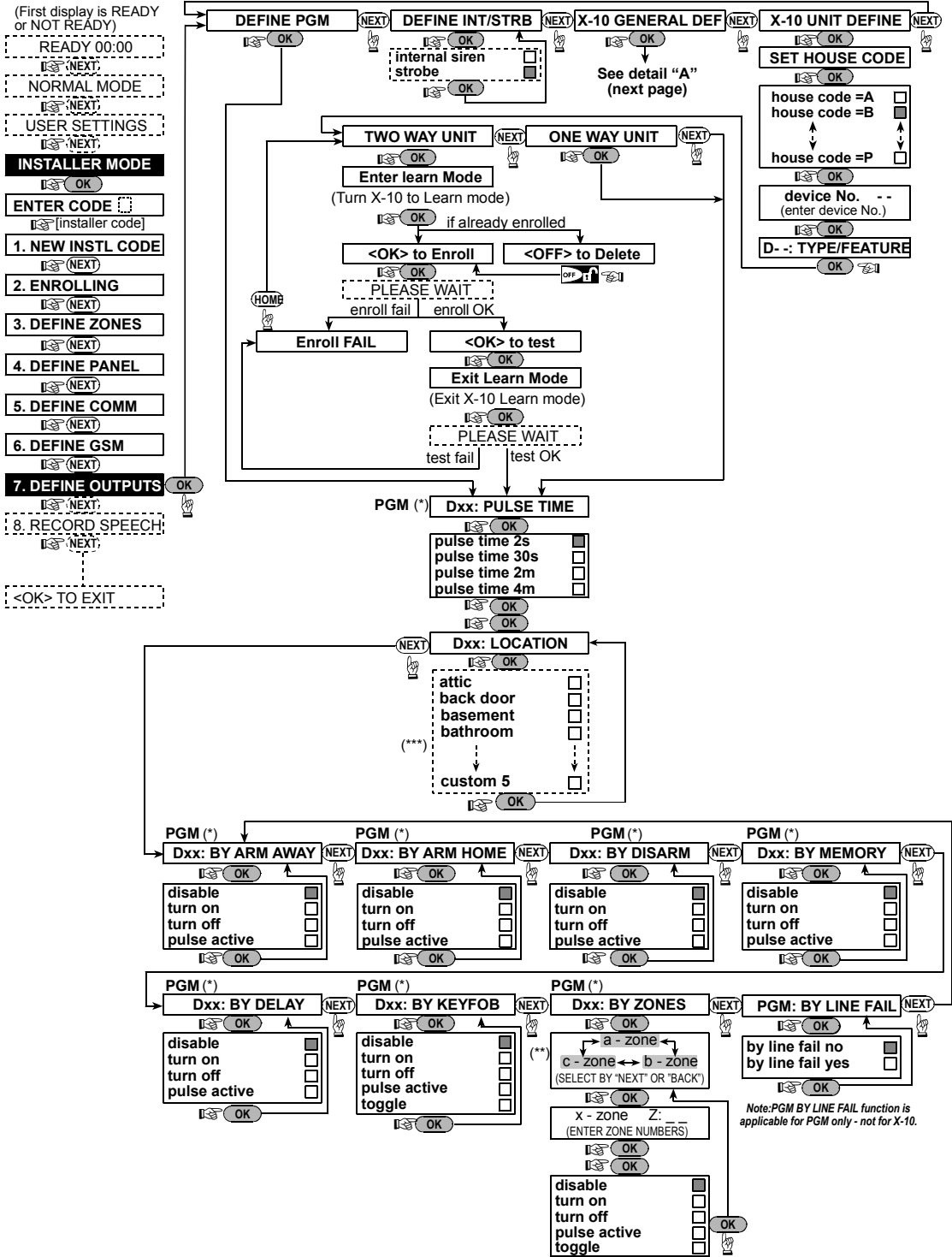


Figure 4.7 - Define Outputs Flow Chart

- \* If PGM is selected, the letters "PGM" will be displayed instead of "Dxx".
- \*\* Upon selecting any one of the 3 options (zone a, b and c) you may enter a zone number and then select "disable", "turn on", "turn off", "pulse active" or "toggle".

\*\*\* The currently saved option is displayed with a dark box at the right side. To review the options, repeatedly click NEXT button until the desired option is displayed, then click OK (a dark box will be displayed at the right side). For zone name list, refer to paragraph 4.3 (DEFINE ZONE TYPES). Each X-10 unit has default zone name ( 01 - front door, 02 - garage, 03 - garage door, 04 - back door, 05 – child room, 06 – office, 07 – dining room, 08- dining room, 09 – kitchen, 10 – living room, 11 – living room, 12 – bedroom, 13 – bedroom, 14 – guest room, 15 – master bedr, 16 – master bedr).

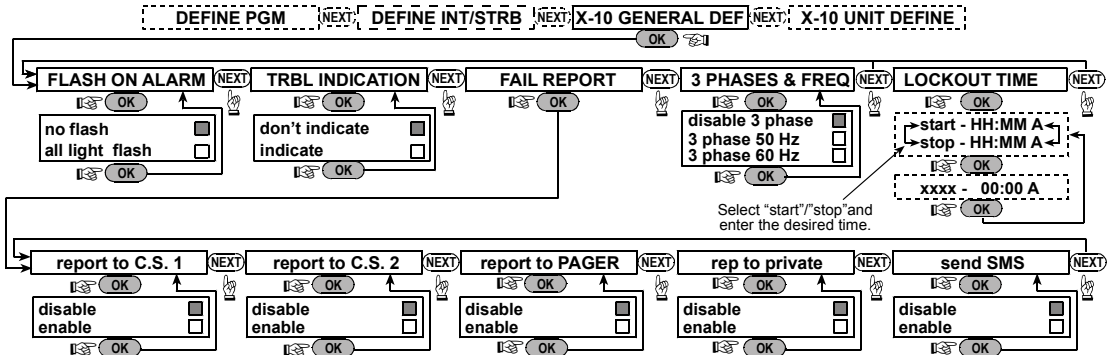


Figure 4.7 - Detail A

## 4.8 RECORDING SPEECH

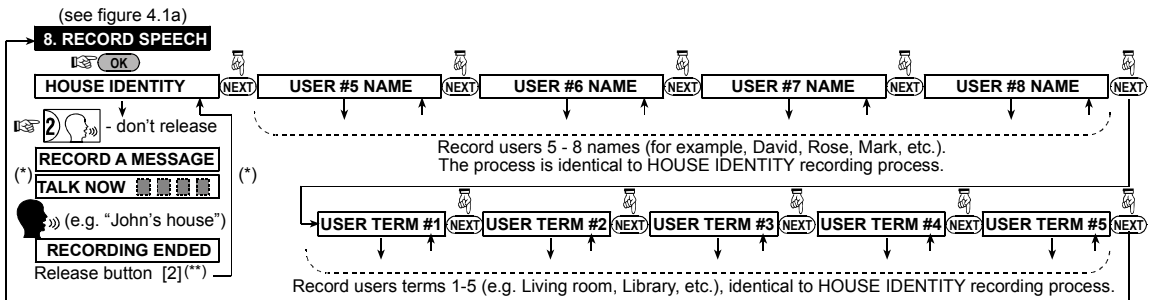
This mode allows you to record short-duration speech messages for the following purposes:

- **House identity** is a message announced automatically when events are reported to private telephones.
- **4 user names** can be recorded and assigned to users number 5-8. In case of event, relevant to such a user,

the user name will be added to the message that will be reported via the telephone.

- **5 custom zone names** can be recorded and assigned to specific zones. These names are useful if none of the 26 fixed zone names are found suitable for a certain zone (see fig. 4.3).

The recording process is shown below.



(\*) RECORD MESSAGE is displayed momentarily. The dark square boxes slowly disappear, one by one, until end of recording time.

(\*\*) To check the recorded message, press the [5] key and listen to the playback.

Figure 4.8 - Speech Recording Flow Chart

## 4.9 DIAGNOSTIC TEST

This mode allows you to test the function of all protected area wireless sensors / wireless sirens and to receive / review information regarding the received signal strength. Three reception levels are sensed and reported:

Received Signal Strength Indication

Reception	Buzzer Response
Strong	Happy Tune twice ( - - - — ) ( - - - — )
Good	Happy Tune ( - - - — )
Poor	Sad tune ( — — — )

The diagnostic test process is shown in figure 4.9.

When you are instructed to perform "walk test", walk throughout the site to check the detectors / sensors. When a detector/sensor is triggered into alarm, its name, number

and the alarm reception level should be indicated (for example, "Bathroom", "Z19 strong") and the buzzer should sound according to the alarm reception level (1 of 3).

**IMPORTANT!** Reliable reception must be assured even when a signal attenuation of up to 6 dB occurs (due to changes in the environment after installation). A "poor" signal is therefore not acceptable. If you get a "poor" signal from a certain detector, re-locate it and re-test until the test result is "good" or "strong". This principle must be adhered to during the initial test and also throughout subsequent system maintenance.

**For UL installation, the test result must be STRONG for all wireless devices.**

(see figure 4.1a)

## 9. DIAGNOSTICS

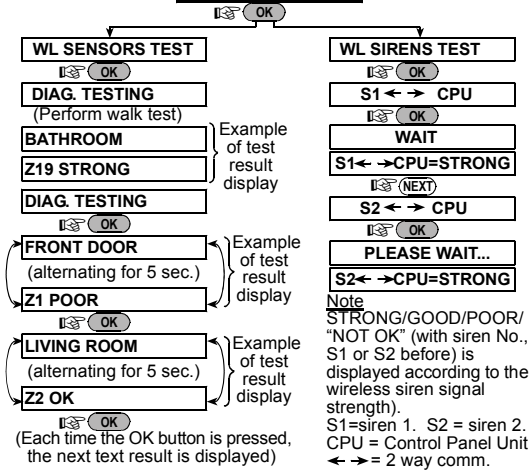


Figure 4.9 - Diagnostic Test Flow Chart

## 4.10 USER FUNCTIONS

This mode provides you with a gateway to the user functions through the regular user programming menu. You may:

- Program the 4 (private) telephone numbers
- Program user codes
- Enroll keyfobs
- Select the voice option
- Set the auto arm option
- Set arming time
- Set the squawk option

- Set the system time and time format
- Set the date and date format
- Set the time scheduler

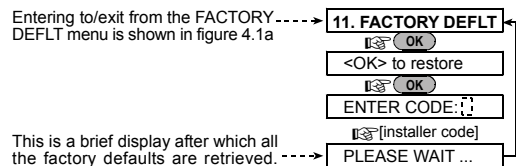
Refer to the User Guide for detailed procedures.

**Caution! If after having programmed the user code the system does not recognize your installer code, this indicates you must have programmed a user code that is identical with your installer code. If so, access the user menu and change the code that is identical with your installer code. This will re-validate your installer code.**

## 4.11 RETRIEVING FACTORY DEFAULTS

If you want to reset the PowerMax+ parameters to the factory default parameters, you should enter the installer menu and perform the "FACTORY DEFLT" function, as described in the right side illustration. To get the relevant parameters defaults, contact the PowerMax+ dealer.

**Note:** For PowerMax+ with 2 installer codes, INSTALLER code and MASTER INSTALLER code, only the master installer code enables to perform factory default function.



## 4.12 SERIAL NUMBER

The menu "12. SERIAL NUMBER" enables reading the system serial number for support purposes only.

## 4.13 CALLING UPLOAD/DOWNLOAD SERVER

This option allows the installer to initiate a call to the upload/download server. The server uploads the

PowerMax+ configuration to its data base and can unload predefined parameters to the PowerMax+.

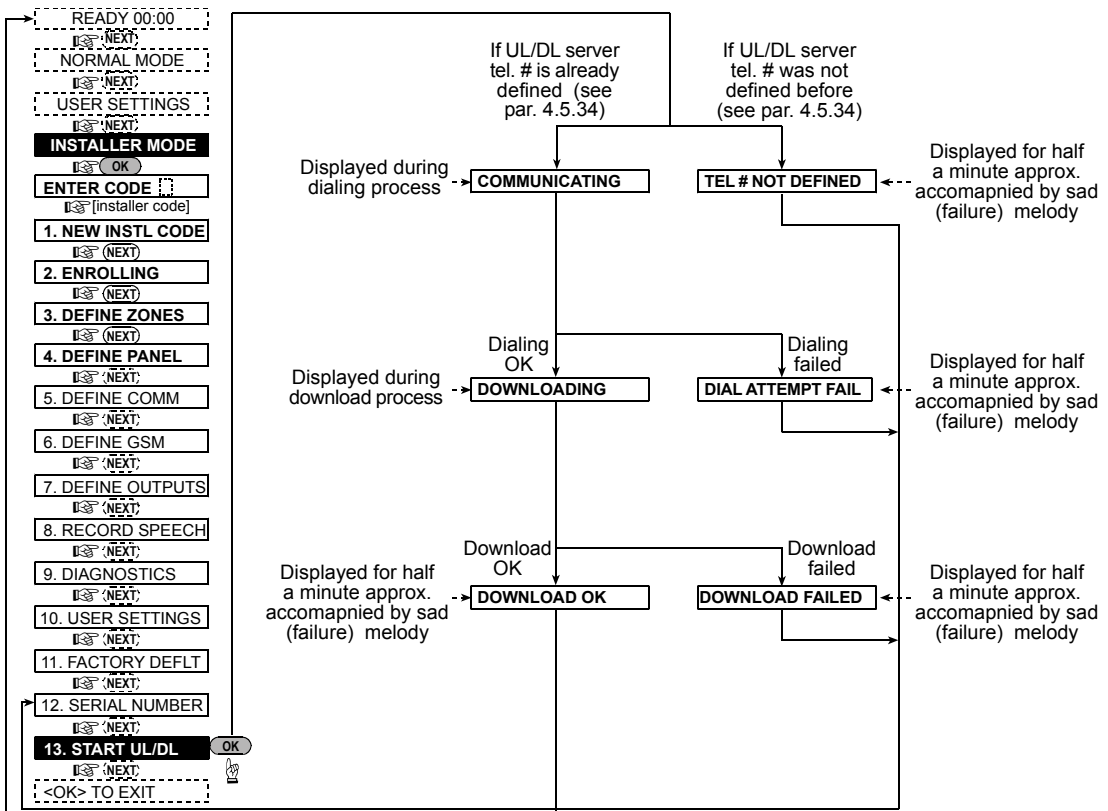


Figure 4.13 – Start UL/DL

## 5. TESTING PROCEDURES

### 5.1 Preparations

Make sure all windows and doors are closed. If all zones are secured (undisturbed), the display should read:

READY HH : MM

If the display is "NOT READY", query the control panel by pressing the <SHOW/OK> button repeatedly. The source(s) of the problem(s) will be displayed and read aloud. Take the necessary measures to eliminate the problem(s) before testing the system (see next paragraph).

### 5.2 Diagnostic Test

To verify proper function of all detectors in the system, a comprehensive diagnostic test is required. To perform this test, refer to figure 4.9.

### 5.3 Keyfob Transmitter Test

Initiate transmission from each transmitter enrolled as a keyfob unit (according to the list in Table A2, Appendix A). Use each transmitter to arm the control panel AWAY and immediately disarm it. Upon pressing the keyfob unit's AWAY key, the ARM indicator should light.

The display should respond as follows:

ARMING AWAY



PLEASE EXIT NOW

The exit delay beeps will begin.

Press the keyfob unit's DISARM (⏏) key. The ARM indicator should extinguish and the announcement "Disarm, ready to arm" should be heard and the display should revert to:

READY HH : MM

Test the AUX button in each keyfob in accordance with the information noted in Table A.2, Appendix A. Verify that the AUX button performs its duty as programmed.

- If the AUX (\*) button is defined as "STATUS", system status should be displayed and announced upon pressing the button.
- If the AUX (\*) button is defined as "INSTANT", press the AWAY button and then the AUX button. The response should be:

ARMING INSTANT

(alternating)

PLEASE EXIT NOW

and the exit delay beeps will start. Press the DISARM (⏏) key immediately to disarm.

- If the AUX (\*) button is programmed as "PGM / X-10" and permitted to activate one or several X-10 units, pressing (\*) should activate the appliance controlled by the chosen X-10 unit(s).
- If the AUX (\*) button is programmed as "PGM / X-10" and permitted to activate the PGM output, pressing (\*) should activate the device wired to the PGM output.

### 5.4 Appliance ON/OFF Test

The "X-10 unit assignment" information that you noted in Appendix B of this manual is very useful for this test.

Go over the table in **Appendix B** column by column. If, for instance, the "BY ARM AWAY" column has "X"s marked in the rows pertaining to units 1, 5 and 15 - then arm AWAY the system and verify that the appliances controlled by these units are actually activated upon arming.

Continue in the same manner in the following columns, always creating the state or event that will activate the relevant units. Verify that all appliances are activated as programmed.

**IMPORTANT!** Before testing "BY TIMER" and "BY ZONE", make sure that these forms of control are permitted - click repeatedly and verify that the display shows:

BY TIMER ON

and:

BY SENSOR ON

A dark box at the extreme right means that these functions are enabled.

The easiest way for test timed activation is to select the ninth item in the installer's menu ("10. USER SETTINGS") and set the system clock a few minutes before the relevant "start time". Do not forget to return the clock to the correct time after completion of this test.

### 5.5 Emergency Transmitter Test

Initiate transmission from each transmitter enrolled to an emergency zone (according to the list in Table A3, Appendix A). For example, upon pressing the transmit button of an emergency transmitter enrolled to zone 22, the display should read:

Z 22 EMERGENCY  
 (alternating)   
 VIOLATED

It is advisable to let the central station know that you are conducting this test, or just disconnect the telephone line from the PowerMax+ during the test, to prevent false alarms.

## 6. MAINTENANCE

### 6.1 Dismounting the Control Panel

A. Release the PowerMax+ unit from its bracket, as shown in figure 3.2, step 1-3.

B. Separate the PowerMax+ unit from its bracket.

### 6.2 Replacing the Backup Battery

Replacement and first-time insertion of battery pack is similar (see figure 3.1).

With fresh battery pack, correct insertion and tightened battery compartment lid, the TROUBLE indicator should extinguish. However, the "MEMORY" message will now blink in the display (caused by the "tamper" alarm you triggered when opening the battery compartment lid). Clear it by arming the system and immediately disarming.

### 6.3 Fuse Replacement

The PowerMax+ has two internal fuses that have automatic reset. Therefore, there is no need to replace fuses.

When overcurrent condition occurs, the fuse cuts off the circuit current. Upon fault current being removed, the fuse is automatically reset and allows current flow through the circuit again.

### 6.4 Replacing/Relocating Detectors

Whenever the maintenance work involves replacement or re-location of detectors, you must keep in mind the requirement to provide a 6 dB safety margin for signal reception. **It is therefore mandatory to perform a full diagnostic test according to par. 4.9.**

**Remember!** A "poor" signal is not acceptable, as stated at the end of the test procedure.

## 7. READING THE EVENT LOG

Up to 100 events can be stored the event log. You can access this log and review the events, one by one. If the event log fills up completely (100 events), the oldest event is deleted upon registration of each new event.

The date and time of occurrence are memorized for each event.

When reading the event log, events are shown in chronological order - from the newest to the oldest. Access to the event log is provided by clicking the key and not through the installer's menu. Reading and erasing process of the event log is shown in the next drawing.

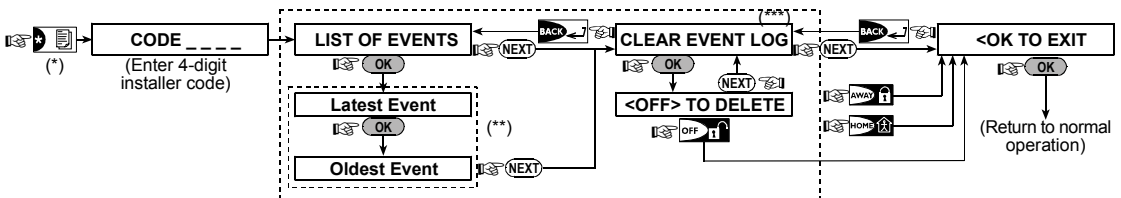


Figure 7 - Reading / Erasing the Event Log

\* While the system is in normal operation mode, click to review the event log.

\*\* Event is displayed in 2 parts, for example, "Z13 alarm" then "09/02/99 3:37 P". The two displays will be shown alternately until clicking OK again to move to the next event or until the end of the event log (4 minutes).

\*\*\* Applicable only if installer code is entered.

# APPENDIX A. Detector Deployment & Transmitter Assignments

## A1. Detector Deployment Plan

Zone No.	Zone Type	Sensor Location or Transmitter Assignment (in non-alarm or emergency zones)	Chime (Yes / No)	Controls PGM (X = YES)	Controls X-10 Unit No.
1					
2					
3					
4					
5					
6					
7					
8					
9					
10					
11					
12					
13					
14					
15					
16					
17					
18					
19					
20					
21					
22					
23					
24					
25					
26					
27					
28					
29 (*)					
30 (*)					

**Zone Types:** 1 = Interior follower \* 2 = Perimeter \* 3 = Perimeter follower \* 4 = Delay 1 \* 5 = Delay 2 \* 6 = 24 h silent \* 7 = 24 h audible \* 8 = Fire \* 9 = Non-alarm \* 10 = Emergency \* 11 = Gas \* 12 = Flood \* 13 = Interior.

**Zone Locations:** Note down the intended location for each detector. When programming, you may select one of 26 available zone names (plus 5 custom zone names that you can add - see Figure 4.3 - Define Zones).

\* Zones 29 & 30 only are hardwired zones.

## A2. Keyfob Transmitter List

Transmitter Data			AUX button Assignments		
No.	Type	Holder	Status or Arming "instant"	PGM Control	X-10 Unit Control
1			Indicate the desired function (if any) – see par. 4.4.17 (Aux button).	Indicate whether this output will be activated or not – see par. 4.7.	Mark the boxes of the X-10 units to be activated - see par. 4.7.
2					
3					
4					
5					
6			System status <input type="checkbox"/>	Yes <input type="checkbox"/> No <input type="checkbox"/>	1 <input type="checkbox"/> 2 <input type="checkbox"/> 3 <input type="checkbox"/> 4 <input type="checkbox"/> 5 <input type="checkbox"/>
7			Arming "instant" <input type="checkbox"/>		6 <input type="checkbox"/> 7 <input type="checkbox"/> 8 <input type="checkbox"/> 9 <input type="checkbox"/> 10 <input type="checkbox"/>
8					11 <input type="checkbox"/> 12 <input type="checkbox"/> 13 <input type="checkbox"/> 14 <input type="checkbox"/> 15 <input type="checkbox"/>

### A3. Emergency Transmitter List

Tx #	Transmitter Type	Enrolled to Zone	Name of holder
1			
2			
3			
4			
5			
6			
7			
8			
9			
10			

### A4. Non-Alarm Transmitter List

Tx #	Transmitter Type	Enrolled to Zone	Name of holder	Assignment
1				
2				
3				
4				
5				
6				
7				
8				
9				
10				

### APPENDIX B. X-10 Unit and PGM Output Assignments

Unit No.	Controlled Appliance	ON by arm HOME	ON by arm AWAY	ON by disarm	ON by Memory	ON by Delay	ON by Keyfob	ON by Timer		ON by Zone No.			ON by line fail
								ON Time	OFF Time	a	b	c	
1													-
2													-
3													-
4													-
5													-
6													-
7													-
8													-
9													-
10													-
11													-
12													-
13													-
14													-
15													-
PGM													

# APPENDIX C. Event Codes

## Contact ID Event Codes

Code	Definition	Code	Definition
101	Emergency	351	Telco fault
110	Fire	373	Fire detector trouble
113	Flood alarm	381	Loss of supervision RF
120	Panic	383	Sensor tamper
121	Duress	384	RF low battery
122	Silent	393	Fire detector clean me
123	Audible	401	O/C by user
131	Perimeter	403	Auto arm
132	Interior	406	Cancel
134	Entry/Exit	408	Quick arm
137	Tamper/CP	426	Door open event
139	Burglary verified	441	Armed home
151	Gas alarm	454	Fail to set event
180	Gas trouble	455	Fail to arm
301	AC loss	456	Partial arm
302	Low system battery	459	Recent close event
311	Battery disconnect	570	Bypass
313	Engineer reset	602	Periodic test report
321	Bell	607	Walk test mode
344	RF receiver jam detect	641	Senior watch trouble
350	Communication trouble		

## SIA Event Codes

Code	Definition	Code	Definition
AR	AC Restore	GJ	Gas trouble restore
AT	AC Trouble	HA	Holdup Alarm (duress)
BA	Burglary Alarm	LR	Phone Line Restore
BB	Burglary Bypass	LT	Phone Line Trouble
BC	Burglary Cancel	OP	Opening Report
BR	Burglary Restore	OT	Fail to Arm
BT	Burglary Trouble / Jamming	PA	Panic Alarm
BV	Burglary Verified	QA	Emergency Alarm
BZ	Missing Supervision	RN	Engineer Reset
CF	Forced Closing	RP	Automatic Test
CI	Fail to Set	RX	Manual Test
CL	Closing Report	RY	Exit from Manual Test
CP	Auto Arm	TA	Tamper Alarm
CR	Recent Close	TR	Tamper Restore
EA	Door Open	WA	Flood alarm
FA	Fire Alarm	WR	Flood alarm restore
FT	Fire Detector Clean	XR	Sensor Battery Restore
FJ	Fire detector trouble	XT	Sensor Battery Trouble
FR	Fire Restore	YR	System Battery Restore
GA	Gas alarm	YT	System Battery Trouble / Disconnection
GR	Gas alarm restore	YX	Service Required
GT	Gas trouble		

## 4/2 Event Codes

Note: Wireless siren reports to central station on zone 31 or 32. GSM reports to central station on zone 33.

### Alarms

Zone #	1	2	3	4	5	6	7	8	9	10	11	12	13	14	15	16	17	18	19	20	21	22	23	24	25	26	27	28	29	30
1 <sup>st</sup> digit	4	4	4	4	4	4	4	4	4	4	4	4	4	4	4	5	5	5	5	5	5	5	5	5	5	5	5	5	5	5
2 <sup>nd</sup> digit	1	2	3	4	5	6	7	8	9	A	B	C	D	E	F	1	2	3	4	5	6	7	8	9	A	B	C	D	E	F

### Restorals

Zone #	1	2	3	4	5	6	7	8	9	10	11	12	13	14	15	16	17	18	19	20	21	22	23	24	25	26	27	28	29	30
1 <sup>st</sup> digit	C	C	C	C	C	C	C	C	C	C	C	C	C	C	C	D	D	D	D	D	D	D	D	D	D	D	D	D	D	D
2 <sup>nd</sup> digit	1	2	3	4	5	6	7	8	9	A	B	C	D	E	F	1	2	3	4	5	6	7	8	9	A	B	C	D	E	F

### Supervisory trouble

Zone #	1	2	3	4	5	6	7	8	9	10	11	12	13	14	15	16	17	18	19	20	21	22	23	24	25	26	27	28
1 <sup>st</sup> digit	6	6	6	6	6	6	6	6	6	6	6	6	6	6	6	7	7	7	7	7	7	7	7	7	7	7	7	7
2 <sup>nd</sup> digit	1	2	3	4	5	6	7	8	9	A	B	C	D	E	F	1	2	3	4	5	6	7	8	9	A	B	C	D

### Low Battery

Zone #	1	2	3	4	5	6	7	8	9	10	11	12	13	14	15	16	17	18	19	20	21	22	23	24	25	26	27	28
1 <sup>st</sup> digit	8	8	8	8	8	8	8	8	8	8	8	8	8	8	8	9	9	9	9	9	9	9	9	9	9	9	9	9
2 <sup>nd</sup> digit	1	2	3	4	5	6	7	8	9	A	B	C	D	E	F	1	2	3	4	5	6	7	8	9	A	B	C	D

### Forced Arming – 8 users

User No.	1	2	3	4	5	6	7	8
1 <sup>st</sup> digit	A	A	A	A	A	A	A	A
2 <sup>nd</sup> digit	1	2	3	4	5	6	7	8

### Zone Bypass

Zone #	1	2	3	4	5	6	7	8	9	10	11	12	13	14	15	16	17	18	19	20	21	22	23	24	25	26	27	28	29	30
1 <sup>st</sup> digit	A	A	A	A	A	A	A	A	A	A	A	A	A	A	A	B	B	B	B	B	B	B	B	B	B	B	B	B	B	B
2 <sup>nd</sup> digit	1	2	3	4	5	6	7	8	9	A	B	C	D	E	F	1	2	3	4	5	6	7	8	9	A	B	C	D	E	F

## Panic / 24 Hours - 8 users

User No.	1	2	3	4	5	6	7	8	Panic CP	Duress
1 <sup>st</sup> digit	2	2	2	2	2	2	2	2	2	2
2 <sup>nd</sup> digit	1	2	3	4	5	6	7	8	9	A

## Arm HOME and AWAY (Closing)

User No.	1	2	3	4	5	6	7	8	Cancel alarm	Recent Close
1 <sup>st</sup> digit	E	E	E	E	E	E	E	E	E	E
2 <sup>nd</sup> digit	1	2	3	4	5	6	7	8	9	C

## Disarm (Opening)

User No.	1	2	3	4	5	6	7	8
1 <sup>st</sup> digit	F	F	F	F	F	F	F	F
2 <sup>nd</sup> digit	1	2	3	4	5	6	7	8

## Trouble

Event	Fuse Fail	Fuse Restore	Jamming	Jamming Restore	AC Failure	AC Restore	CPU Low Battery	CPU Low Battery Restore	CP Tamper
1 <sup>st</sup> digit	2	2	2	2	1	1	1	1	1
2 <sup>nd</sup> digit	C	D	E	F	1	2	3	4	6

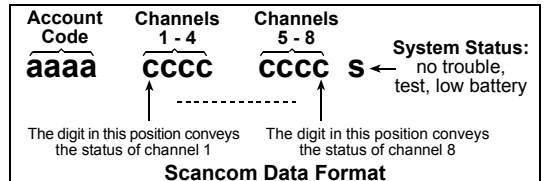
Event	CP Tamper Restore	No Active	COMM. & LINE Restore	Enter Test	Exit Test	Auto Test
1 <sup>st</sup> digit	1	1	1	1	1	1
2 <sup>nd</sup> digit	7	8	A	D	E	F

## Understanding the Scancom Reporting Protocol Data Format

The SCANCOM data format consists of 13 decimal digits divided into 4 groups, from left to right, as shown at the right side.

Each channel is associated with a specific event as follows:

- 1<sup>st</sup> "C": Fire
- 2<sup>nd</sup> "C": Personal attack
- 3<sup>rd</sup> "C": Intruder
- 4<sup>th</sup> "C": Open/close
- 5<sup>th</sup> "C": Alarm cancel
- 6<sup>th</sup> "C": Emergency
- 7<sup>th</sup> "C": Second alarm
- 8<sup>th</sup> "C": Trouble messages



## APPENDIX D. Programmable Zone Types

### D1. Delay Zones

A delay zone has exit and entry delays set by you in the course of programming the system. Warning beeps will sound throughout these delays, unless you choose to mute them.

- **Exit Delay** - The exit delay begins once the user arms the system. It allows him to leave via interior zones and a doorway before arming actually takes effect. When the exit delay starts, the buzzer beeps slowly and maintains a slow beeping rate until the last 10 seconds, during which it beeps rapidly. The PowerMax+ has two types of delay zones, for which different delay times may be set.
- **Entry Delay** - The entry delay begins once the user enters the protected area via a specific doorway (his entry is sensed by a delay zone detector). To avoid an alarm, he must reach the keypad via interior zones (which become "follower zones" during the entry delay) and disarm the system before the delay expires. When the entry delay starts, the buzzer beeps slowly until the last 10 seconds, during which it beeps rapidly.

### D2. Emergency Zones

You can provide incapacitated, sick or elderly people with a miniature single-button transmitter to be carried on the neck like a pendant or to be worn on the wrist like a watch. In distress situations, they can press the button on their transmitter, causing the PowerMax+ to send an **emergency call** to the central monitoring station or to private telephones designated by the installer.

To make this possible, define the required number of zones as emergency zones and enroll a portable transmitter to each one of these zones. When completed, ask the master user to distribute these transmitters to their potential users.

### D3. Fire Zones

A fire zone uses smoke detectors and is permanently active (a fire alarm is triggered regardless of whether the system is armed or disarmed). Upon detection of smoke, a **pulsating siren** sounds immediately and the event is reported via the telephone line.

## D4. Flood Zone

A flood zone is permanently active (a flood alarm is triggered regardless of whether the system is armed or disarmed). Upon detection of flood leak, the event is reported via the telephone line.

## D5. Gas Zone

A gas zone is permanently active (a gas alarm is triggered regardless of whether the system is armed or disarmed). Upon detection of gas leak, the event is reported via the telephone line.

## D6. Interior Zone

Interior zone is a zone inside the protected site. When an intruder enters to such a zone an immediate alarm is initiated.

## D7. Interior Follower Zones

A non-entry/exit zone, typically an interior zone located on an entry/exit path that is treated as an entry/exit zone during an entry/exit time.

## D8. Non-Alarm Zones

A non-alarm zone does not directly participate in the alarm system. Its main use is to perform auxiliary remote control tasks such as opening/closing a gate, activating/deactivating courtesy light and similar applications. No alarm, silent or otherwise, is associated with a non-alarm zone.

For remote control of electrical devices, you can define the desired number of non-alarm zones and enroll a portable transmitter or a wireless device (detector) to this type of zone. Then, you must ensure that these zones are permitted to control the PGM output, or the X-10 units or both (see par. 4.7). Next, you can select the zones (3 at most) that will control each output. The outputs, in turn, will control the external electrical devices.

**Note:** A device control can also be carried out by holders of all keyfob transmitters, by pressing the AUX [\*] button.

This method will work provided that you programmed the [\*] button for PGM/X-10 control (see Para. 4.4.17), and that you programmed the PGM output and the X-10 units to be controlled by keyfob transmitters (see par. 4.7).

## D9. Perimeter Zones

Perimeter zones rely on detectors designed to protect doors, windows and walls. An immediate alarm is initiated when such a zone is violated by opening the door/window or by trying to break the wall.

## D10. Perimeter Follower Zones

A non-entry/exit zone, typically a perimeter zone located on an entry/exit path, that is treated as an entry/exit zone during an entry/exit time.

## D11. 24-Hour Zones

24 hour zones are mainly used for PANIC buttons, perimeter detectors and anti-tamper protection. They therefore trigger an alarm in both armed and disarmed states.

- **24 Hour Zone - Silent.** - Upon detection, this zone initiates a silent alarm, meaning that the sirens do not function. Instead the PowerMax+ dials telephone numbers and reports the event to central stations and/or to private telephones, as programmed.
- **24 Hour Zone - Audible.** - Upon detection, this zone initiates a siren alarm. The PowerMax+ also dials telephone numbers and reports the event to central stations and/or to private telephones, as programmed.

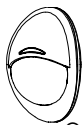
## APPENDIX E. PowerMax+ Compatible Devices

### E1. PowerMax+ Compatible Detectors

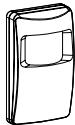
Each detector compatible with the PowerMax+ system is packed with its own installation instructions. Read them carefully and install as indicated.

#### A. PIR Motion Detectors

The wireless passive infrared (PIR) motion detectors used in the system are of the PowerCode type. The PowerMax+ is capable of "learning" each detector's identification code and linking it to a specific zone (see par. 4q.3 in this Guide). Some units are shown below:



**NEX T**<sup>®</sup>  
K9-85 MCW



**MCPIR-3000**  
or K-940 MCW



**DISCOVERY**  
K9-80/MCW

**MCPIR-3000 is not UL-listed!**

**Note:** K-940 MCW, Discovery K9-80/MCW and NEX T<sup>®</sup> K9-85 MCW are pet immune units.

In addition to its unique 24-bit identification code, each detector transmits a message, containing status information:

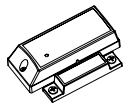
- The detector is in alarm (or not).
- The detector is being tampered with (or not).
- The battery voltage is low (or normal).

- "This is a supervisory message".

If any of these detectors detects motion, it sends out a message to the alarm control panel. If the system is in the armed state, an alarm will be triggered.

#### B. Magnetic Contact Transmitter

MCT-302 is a PowerCode magnetic-contact transmitter used to detect the opening of a door or a window. The alarm contacts are closed as long as the door or window remains closed.

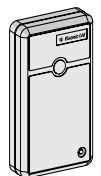


**MCT-302**

The unit has an extra alarm input that acts as if it were a separate wireless transmitter. It sends (or does not send) a "restored to normal" message to the alarm system, depending on the setting of an on-board "DIP" switch. The "restore" message informs you, through the control panel's display, whether the door or window is open or closed.

#### C. MCT-100 Wireless Adapter for Wired Detectors

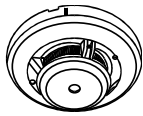
(not UL-Listed) MCT-100 is a PowerCode device used mainly as a wireless adapter for 2 regular magnetic switches installed on 2 windows in the same room. It has two inputs, behaving as separate wireless transmitters with different PowerCode IDs. Each input sends (or does not send) a "restored" message to the alarm system, depending on the setting of an on-board "DIP" switch.



**MCT-100**

**D. Wireless Smoke Detector MCT-430 (UL-listed).**

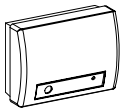
A photoelectric smoke detector equipped with a PowerCode-type transmitter. If enrolled to a fire zone, it initiates a fire alarm upon detection of smoke.



**MCT-430**

**E. Glass Break Detector MCT-501 (not UL-Listed).**

An acoustic detector equipped with a PowerCode-type transmitter. Since it restores automatically after detection, this unit does not send a restoral message to the control panel.



**MCT-501**

**E2 PowerMax+ Compatible Transmitters**

*Note: Each transmitter is packed with its own instructions for battery installation and use. Be sure to pass these documents on to the "Master User" of the alarm system.*

The PowerMax+ system is compatible with multi-button and single button key-ring and hand-held transmitters that use PowerCode and CodeSecure coding methods.

Multi-button PowerCode transmitters transmit the same code each time the same button is pressed. They can be used for emergency signaling, for activating the PGM output or for controlling appliances via X-10 units. **They can not be used for arming / disarming.**

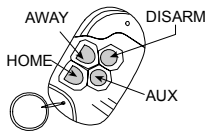
CodeSecure transmitters are of the rolling code type - they transmit a new code each time the same button is pressed. This provides a higher security level, especially in arming / disarming applications, because the code can not be copied ("grabbed") by unauthorized people.

Following are the basic details of several compatible transmitters. The possible applications for each push-button are indicated in each drawing.

**A. MCT-234**

'Keyfob' transmitter - one unit is supplied with PowerMax+. You can program the AUX (auxiliary) button to perform various tasks, in accordance with the user's needs.

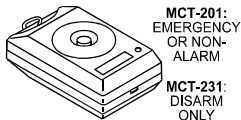
Pressing AWAY and HOME together for 2 sec. initiates PANIC alarm. Pressing AWAY for 2 sec. initiates Latchkey arming.



**MCT-234**

**B. MCT-231 / 201\***

(N.A. in North America) Single-button pendant units. The MCT-231 (Code-Secure) and the MCT-201 (PowerCode) can be enrolled to perform functions as shown. Both units look alike.

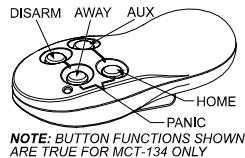


**MCT-231 / 201**

\* Not UL listed.

**C. MCT-134 / 104\***

(N.A. in North America) 4-button hand-held units. MCT-134 (CodeSecure) can replace the MCT-234 keyfob. MCT-104 (PowerCode) can perform emergency and non-alarm functions. Both units look alike.

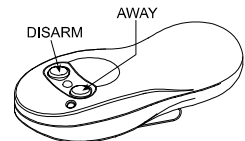


**NOTE: BUTTON FUNCTIONS SHOWN ARE TRUE FOR MCT-134 ONLY**

**MCT-134 / 104**

**D. MCT-132 / 102\***

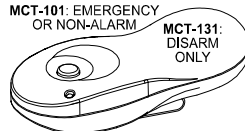
(N.A. in North America) 2-button units. MCT-132 (CodeSecure) can perform functions as shown. MCT-102 (PowerCode) can perform emergency and non-alarm tasks. Both units look alike.



**MCT-132 / 102**

**E. MCT-131 / 101\***

(N.A. in North America) Single-button units. The MCT-131 (CodeSecure) and the MCT-101 (PowerCode) can be enrolled to perform functions as shown. Both units look alike.

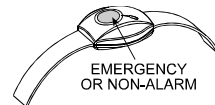


**MCT-101: EMERGENCY OR NON-ALARM**      **MCT-131: DISARM ONLY**

**MCT-131 / 101**

**F. MCT-211\***

Water-proof, wrist-worn Power-Code transmitter. Can be enrolled to perform emergency or non-alarm functions.

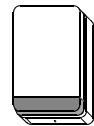


**MCT-211**

\* Not UL-listed - not to be used in UL-listed systems

**E3 PowerMax+ Compatible WL Siren**

The MCS-700 (\*) wireless siren can be integrated with the PowerMax+ in areas in which wiring action is difficult or impossible. The MCS-700 is a fully supervised, 2-way communication device (it includes a receiver, to receive activation commands from the alarm system, and a transmitter to periodically transmit its status signal to the alarm system).



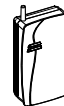
**Wireless Siren**

When an identifiable activation command is received from the PowerMax+, the siren activates its sounder and the flash light (strobe light every 1.5 seconds).

\* Not UL-listed - not to be used in UL-listed systems

**E4. PowerMax+ Compatible GSM Modem**

The GSM modem enables the PowerMax+ system to operate over cellular network. For details regarding the GSM modem features and connections, refer to the GSM Modem installation instructions.



**GSM Modem**

# Federal Communications Commission (FCC) Statements

## FCC PART 15 STATEMENT

This device complies with Part 15 of the FCC Rules. Operation is subject to the following two conditions: (1) This device may not cause harmful interference, and (2) This device must accept any interference received, including interference that may cause undesired operation.

**WARNING! Changes or modifications to this unit not expressly approved by the party responsible for compliance could void the user's authority to operate the equipment.**

The digital circuits of this device has been tested and found to comply with the limits for a Class B digital device, pursuant to Part 15 of the FCC Rules. These limits are designed to provide reasonable protection against harmful interference in residential installations. This equipment generates, uses and can radiate radio frequency energy and, if not installed and used in accordance with the instructions, may cause harmful interference to radio and television reception. However, there is no guarantee that interference will not occur in a particular installation. If this device does cause such interference, which can be verified by turning the device off and on, the user is encouraged to eliminate the interference by one or more of the following measures:

- Re-orient or re-locate the receiving antenna.
- Increase the distance between the device and the receiver.
- Connect the device to an outlet on a circuit different from the one which supplies power to the receiver.
- Consult the dealer or an experienced radio/TV technician.

## FCC PART 68 STATEMENT

This equipment complies with Part 68 of the FCC rules. On the front cover of this equipment is a label that contains, among other information, the FCC registration number and ringer equivalence number (REN) for this equipment. If requested, this information must be provided to the telephone company.

This equipment uses the following jacks: An RJ31X is used to connect this equipment to the telephone network. The REN is used to determine the quantity of devices which may be connected to the telephone line. Excessive RENs on the telephone line may result in the devices not ringing in response to an incoming call. In most, but not all areas, the sum of the RENs should not exceed five (5.0). To be certain of the number of devices that may be connected to the line, as determined by the total RENs, contact the telephone company to determine the maximum REN for the calling area. If this equipment causes harm to the telephone network, the telephone company will notify you in advance that temporary discontinuance of service may be required. If advance notice is not practical, the telephone company will notify the customer as soon as possible. Also, you will be advised of your right to file a complaint with the FCC if you believe necessary. The telephone company may make changes in its facilities, equipment, operations, or procedures that could affect the operation of the equipment. If this happens, the telephone company will provide advance notice that will enable you to make the necessary modifications in order to maintain uninterrupted service.

If trouble is experienced with this equipment, please contact the manufacturer for repair and warranty information. If the trouble is causing harm to the telephone network, the telephone company may request that you remove the equipment from the network until the problem is resolved.

There are no user serviceable components in this product, and all necessary repairs must be made by the manufacturer. Other repair methods may invalidate the FCC registration on this product.

This equipment cannot be used on telephone company-provided coin service. Connection to Party Line Service is subject to state tariffs.

When programming or making test calls to an emergency number, briefly explain to the dispatcher the reason for the call. Perform such activities in the off-peak hours; such as early morning or late evening.

Alarm dialing equipment must be able to seize the telephone line and place a call in an emergency situation. It must be able to do this even if other equipment (telephone, answering system, computer modem, etc.) already has the telephone line in use. To do so, alarm dialing equipment must be connected to a properly installed RJ31X jack that is electrically in series with and ahead of all other equipment attached to the same telephone line. If you have any questions concerning these instructions, you should consult your telephone company or a qualified installer about installing the RJ31X jack and alarm dialing equipment for you.

## Supplier Declaration of Conformity (SdoC)

Visonic, located at 30, 24 Habarzel street, Tel Aviv 69710, Israel, hereby certifies that the Wireless Alarm Control Panel model "PowerMax+", bearing the labeling identification number US:VSOAL03BPOWERMAX+ complies with the Federal Communication Commission's ("FCC") Rules and Regulations 47 CFR Part 68, and the Administrative Council on Terminal Attachments ("ACTA") adopted technical criteria: TIA/EIA/IS-968, Telecommunications - Telephone Terminal Equipment - Technical Requirements for Connection of Terminal Equipment to the Telephone Network, July 2001.

09/10/2002

Yaacov Kottlicki

Chairman

## Declaration of Conformity

In Accordance with R & TTE Directive of 1999/5/EC

We, the undersigned,

Company: <b>Visonic Ltd</b>
Address: <b>24, Habarzel Street , Tel-Aviv 61220</b>
Country: <b>Israel</b>
Telephone number: <b>+972 3 6456789</b>
Fax number: <b>+972 3 6456788</b>

certify and declare under our sole responsibility that the following equipment:

Type	Product description / Supplementary info
PowerMax +	30 zones fully -supervised Wireless Control Panel (Burglar/Intrusion and smoke Alarm )

is tested and conforms with the following standards:

Standard
EMC ETSI EN 301 489-3 V1.4.1 , Electromagnetic Compatibility and Radio Spectrum Matters (ERM) ; Electromagnetic Compatibility (EMC) standard for radio equipment and services; Part 3: Specific conditions for Short-Range Devices (SRD) operating on frequencies between 9 kHz and 40 GHz EN 50130-4 (1996)+ A1(1998), Immunity requirements for components of fire, intruder and social alarm systems. Radio EN 300 220-3, V 1.1.1 (2000) RES; Electromagnetic compatibility and Radio Spectrum Matters (ERM); Short range devices (SRD); Radio equipment to be used in the 25 MHz to 1000 Mhz frequency range with powerlevels ranging up to 5000mW. Part 3 : harmonized EN covering essential requirements under article 3.2 of the R&TTE directive. EN 60950+ Am1(93), Am2(93), Am3(95), Am4(97). Safety of Information technology equipment including electrical business equipment pr EN 50131-5-3 (2003) Alarm systems-Intrusion systems Part 5-3 : Requirements for interconnections equipment using radio frequency techniques

and therefore complies with the essential requirements and provisions of the **Directive 1999/5/EC** of the European Parliament and of the council of 9 march 1999 on Radio equipment and Telecommunications Terminal Equipment and the mutual recognition of their conformity and Annex III (Conformity Assessment procedure referred to in article 10(4)).

The following Notified Bodies and/or independent laboratories have been consulted in the Conformity Assessment procedure:

Notified Body number/Lab	Name and address
	Hermon Labs, Rakevet Ind. Zone , PoBox 23 Binyamina 30550 Israel

The technical documentation as required by the Conformity Assessment procedure is kept at the following address:

Company: <b>Visonic Ltd.</b>
Address: <b>Fraser Road</b>
<b>Priory Business Park</b>
<b>Bedford, MK44 3WH</b>
Country: <b>UK</b>
Telephone number: <b>0870 7300800</b>
Fax number: <b>0870 7300801</b>

### WARRANTY

*Visonic Ltd. and/or its subsidiaries and its affiliates ("the Manufacturer") warrants its products hereinafter referred to as "the Product" or "Products" to be in conformance with its own plans and specifications and to be free of defects in materials and workmanship under normal use and service for a period of twelve months from the date of shipment by the Manufacturer. The Manufacturer's obligations shall be limited within the warranty period, at its option, to repair or replace the product or any part thereof. The Manufacturer shall not be responsible for dismantling and/or reinstallation charges. To exercise the warranty the product must be returned to the Manufacturer freight prepaid and insured.*

*This warranty does not apply in the following cases: improper installation, misuse, failure to follow installation and operating instructions, alteration, abuse, accident or tampering, and repair by anyone other than the Manufacturer.*

*This warranty is exclusive and expressly in lieu of all other warranties, obligations or liabilities, whether written, oral, express or implied, including any warranty of merchantability or fitness for a particular purpose, or otherwise. In no case shall the Manufacturer be liable to anyone for any consequential or incidental damages for breach of this warranty or any other warranties whatsoever, as aforesaid.*

*This warranty shall not be modified, varied or extended, and the Manufacturer does not authorize any person to act on its behalf in the modification, variation or extension of this warranty. This warranty shall apply to the Product only. All products, accessories or attachments of others used in conjunction with the Product, including batteries, shall be covered solely by their own warranty, if any. The Manufacturer shall not be liable for any damage or loss whatsoever, whether directly, indirectly, incidentally, consequentially or otherwise, caused by the malfunction of the Product due to products, accessories, or attachments of others, including batteries, used in conjunction with the Products.*

*The Manufacturer does not represent that its Product may not be compromised and/or circumvented, or that the Product will prevent any death, personal and/or bodily injury and/or damage to property resulting from burglary, robbery, fire or otherwise, or that the Product will in all cases provide adequate warning or protection. User understands that a properly installed and maintained alarm may only reduce the risk of events such as burglary, robbery, and fire without warning, but it is not insurance or a guarantee that such will not occur or that there will be no death, personal damage and/or damage to property as a result.*

*The Manufacturer shall have no liability for any death, personal and/or bodily injury and/or damage to property or other loss whether direct, indirect, incidental, consequential or otherwise, based on a claim that the Product failed to function. However, if the Manufacturer is held liable, whether directly or indirectly, for any loss or damage arising under this limited warranty or otherwise, regardless of cause or origin, the Manufacturer's maximum liability shall not in any case exceed the purchase price of the Product, which shall be fixed as liquidated damages and not as a penalty, and shall be the complete and exclusive remedy against the Manufacturer.*

*Warning: The user should follow the installation and operation instructions and among other things test the Product and the whole system at least once a week. For various reasons, including, but not limited to, changes in environmental conditions, electric or electronic disruptions and tampering, the Product may not perform as expected. The user is advised to take all necessary precautions for his /her safety and the protection of his/her property.*

6/91



**VISONIC LTD. (ISRAEL):**  
**VISONIC INC. (U.S.A.):**  
**VISONIC LTD. (UK):**  
**INTERNET:**  
 ©VISONIC LTD. 2004

P.O.B 22020 TEL-AVIV 61220 ISRAEL. PHONE: (972-3) 645-6789. FAX: (972-3) 645-6788  
 10 NORTHWOOD DRIVE, BLOOMFIELD CT. 06002-1911. PHONE: (860) 243-0833, (800) 223-0020. FAX: (860) 242-8094  
 FRASER ROAD, PRIORY BUSINESS PARK, BEDFORD MK44 3WH. PHONE: (0870) 730-0800 FAX: (0870) 730-0801  
[www.visonic.com](http://www.visonic.com)  
 POWERMAX+ Installer guide DE5467IP (REV. 0, 2/04)



MADE IN ISRAEL